

MODEL: VOLCANO EPX



VOLCANO

EPX 1/10 SCALE MONSTER TRUCK
OWNERS MANUAL



FAST • AFFORDABLE • FUN™

MAN-VOLCANOEPX-2017-2-10

- To ensure that you are using the most recent version of this manual:
www.redcatracing.com/manuals/VOLCANOEPXMANUAL.pdf
- To ensure that you have the most recent version of the Electric Vehicles Manual:
www.redcatracing.com/manuals/ELECTRIC-MANUAL.pdf

WARNING!

READ ALL INSTRUCTIONS INCLUDED WITH VEHICLE BEFORE OPERATING

**AGE WARNING!**

This radio controlled (RC) vehicle is not a toy! You must be 14 years of age or older to operate this vehicle. Adult supervision is required.

**RISK OF RUNAWAY VEHICLE OR INJURY!**

Never turn on the vehicle or plug in the battery pack without first having the controller turned on.

**RISK OF FIRE! / RISK OF EXPLOSION!**

There is a risk of fire and explosion when dealing with batteries. Rechargeable batteries may become hot and catch fire if left unattended or charged too quickly. Use extra caution when charging LiPO batteries. Use only LiPO specific chargers. Use a LiPO safe charging pouch when charging LiPOs. Charge away from flammable materials. Never charge at a rate higher than 1C. {2000Mah pack= 2amps charge rate). Overcharging can lead to fire and explosion. Always store battery packs in a cool dry place.

**RISK OF BURNS!**

The batteries, electronic speed controller (ESC), electric motor, and other areas of the vehicle can get hot. Burns can occur if touched after vehicle operation. Allow adequate time to cool before handling.

**RISK OF ELECTRICAL SHOCK!**

Use caution when charging batteries. Do not touch positive and negative leads together. Do not lay battery on metal. Use only chargers specified for the battery type being charged. Keep batteries and chargers away from water.

**RISK OF INJURY!**

Hobby grade RC vehicles can cause serious injury or death if not operated correctly. Never use vehicle in crowds. Never chase people or animals. Drive in safe open areas only. Keep body parts away from moving parts.

**RISK OF DAMAGE!**

Never operate RC vehicles on public roads. Damage of vehicle and property can occur. Only operate on open private property. Never charge the battery pack while it is still plugged into the RC vehicle. Always unplug the battery pack from the electronic speed controller (ESC) and remove the battery from the RC vehicle before charging. Failure to do so will result in damage to the vehicle's electronics.

**WARNING!**

Do not mix old and new batteries. Do not mix alkaline, lithium, standard (carbon zinc), or rechargeable (nickel cadmium) batteries. Do not change or charge batteries in a hazardous location.



FCC Compliance Statement! The radio included with your vehicle complies with part 15 of the FCC Rules. Operation is subject to the following two conditions: (1) This device may not cause harmful interference, and (2) This device must accept any interference received, including interference that may cause undesired operations. Note: This equipment has been tested and found to comply with the limits for a Class B digital device, pursuant to Part 15 of the FCC Rules. These limits are designed to provide reasonable protection against harmful interference in a residential installation. This equipment generates, uses and can radiate radio frequency energy and, if not installed and used in accordance with the instructions, may cause harmful interference to radio communications. However, there is no guarantee that interference will not occur in a particular installation. If this equipment does cause harmful interference to radio or television reception, which can be determined by turning the equipment off and on, the user is encouraged to try to correct the interference by one of the following measures:

Reorient or relocate the receiving antenna.

Increase the separation between the equipment and receiver.

Connect the equipment into an outlet on a circuit different from that to which the receiver is connected.

Consult the dealer or an experienced radio/TV technician for help.

WARNING: Any changes or modifications not expressly approved by the party responsible for compliance could void the user's authority to operate this equipment.

WARNING: While operating the Radio, a separation distance of at least 20 centimeters must be maintained between the radiating antenna and the body of the user or nearby persons in order to meet the FCC RF exposure guidelines.

FEATURES & SPECIFICATIONS

- Electric Brushed 19T 550 Motor
- Brushed ESC
- 4 Wheel Drive
- Aluminum Capped Oil Filled Shocks
- 7.2v NiMH Battery
- NiMH Charger Included
- 2.4GHz Radio System
- Scale: 1/10
- Length: 400mm
- Width: 310mm
- Height: 185mm
- Wheelbase: 275mm
- Ground Clearance: 30mm

VEHICLE OVERVIEW

- A: On/Off Switch
- B: Motor
- C: ESC
- D: Receiver
- E: Steering Servo
- F: Steering Linkage
- G: NiMH Battery
- H: Battery Hold Down
- I: Battery Connector

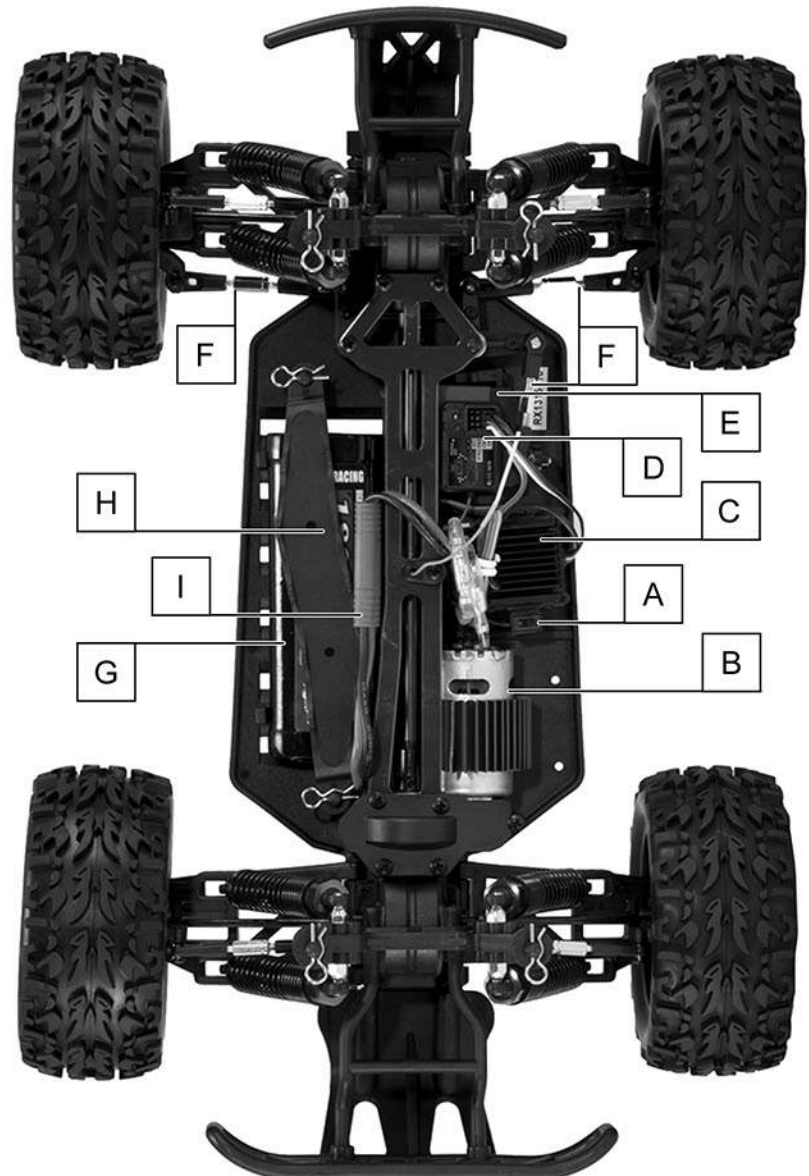

RADIO GUIDE

RCR-2C
 2.4 GHZ RADIO

CONTROL PANEL

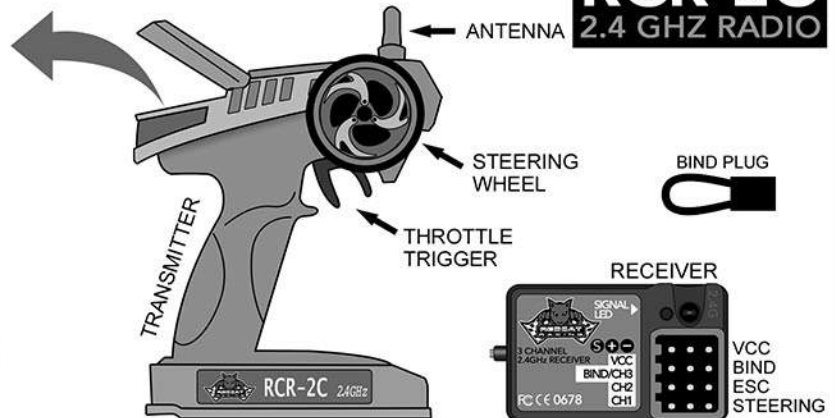

Steering Reverse Switch: Top left switch. Used to change steering orientation. If the car turns right when you steer left, flip this switch.

Throttle Reverse Switch: Top right switch. Used to change throttle trigger orientation. If the car goes in reverse while you pull the throttle trigger, flip this switch.

Power LED: Left LED light. Lights up when the transmitter is turned on.

Battery Level LED: Right LED light. Lights up green when transmitter batteries are full. Flashes when transmitter batteries are low and need replacing.

Bind Button: Used to bind the transmitter to the receiver. See binding instructions.

Steering Trim: Left knob. Used to set the steering neutral point. If the vehicle veers in one direction while the steering wheel is centered, turn this knob in the opposite direction until the car drives straight.

Throttle Trim: Middle knob. Used to set the throttle neutral point. If the vehicle moves forward or reverse while the throttle trigger is centered, turn this knob until the vehicle remains still. For maximum setting, turn slowly until the vehicle creeps forward, then turn the knob the opposite direction until the car stops.

Steering Dual Rate: Right knob. Used to limit the amount of steering. 0= little/no steering & 6= maximum steering. Set the knob to the amount of steering you feel comfortable with. If the vehicle has a tendency to spin out, lower the steering rate.

On/Off Switch: Bottom switch. Turns transmitter On and Off.

VCC: Not used.

Bind/Ch3: Used when binding to transmitter. Used for 3rd channel when needed.

Ch2: Used for Electronic Speed Controller.

Ch1: Used for steering servo.

Binding:

1. Insert the BIND PLUG into the receiver BIND port.
2. Make sure your ESC is plugged into CH2, and insert the bind plug into BIND/CH3. Now, power the vehicle on and the receiver light should begin to blink red.
3. Press the BIND button in the center of the transmitter's Control Panel and turn on radio.
4. Release the bind button when you see the green light on the radio flashing. At this point, your receiver's LED should now be solid red. Turn off the power to your vehicle, as well as the radio.
5. Remove the BIND PLUG from the receiver. Make sure the servos and ESC are attached as described above.
6. First turn your radio on, then your vehicle as normal. Your radio and receiver should be bound together and communicating with each other.

CHARGERS

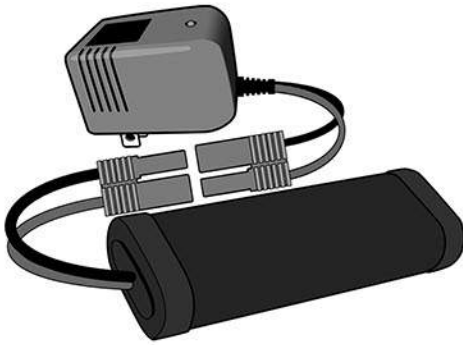

ATTENTION

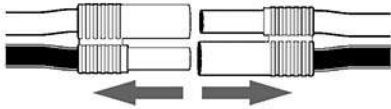

Before attempting to charge your NiMH battery, be sure to remove it from the vehicle and place it on a nonflammable surface away from hazards, such as curtains, couches, or clothing.

Warning! Batteries can potentially catch fire if over charged or charged incorrectly.

NiMH Charging:

Charging NiMH battery packs with the included charger is simple.

1. Unplug and remove the battery from the RC vehicle.
2. Plug the charger into a 110v wall receptacle.
3. Plug the battery pack into the charger.

When plugging the battery into the charger, ensure the red (POS+) wire on the battery is connected to the red (POS+) wire of the charger. Also ensure the black (NEG-) wire on the battery is connected to the black (NEG-) wire of the charger.

Charge times vary according to charger current and battery mAh. **Battery mAh ÷ Charger mA = Approximate charge time**

Ex. 2000mAh battery ÷ 500 mA charger = ~4 hours charge time.

BATTERY CHARGER	2000mAh	2200mAh	3000mAh	3800mAh
250mA	8 hrs	8.8 hrs	12 hrs	15.2 hrs
500mA	4 hrs	4.4 hrs	6 hrs	7.6 hrs
650mA	3 hrs	3.4 hrs	4.6 hrs	5.8 hrs

ATTENTION

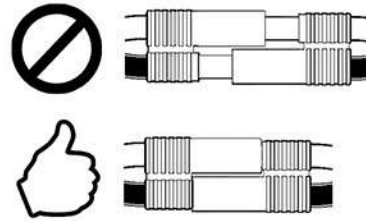

BATTERY CONNECTION INSTRUCTIONS:
Make sure battery connectors are fully pushed in when charging and connecting to the vehicle.

ATTENTION

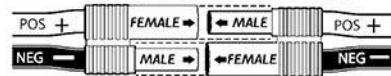

Be sure the wires are correctly orientated when plugging the battery into the vehicle.

When plugging the battery into the vehicle, Ensure the red (POS+) wire on the battery is connected to the red (POS+) wire of the ESC. Also ensure the black (NEG-) wire on the battery is connected to the black (NEG-) wire of the ESC.

Improper connection may damage electronics.



WARNING



UNPLUG THE BATTERY PACK FROM THE VEHICLE!

BEFORE CHARGING YOUR BATTERY PACK, YOU MUST FIRST UNPLUG IT FROM THE ESC. FAILURE TO UNPLUG THE BATTERY FROM THE VEHICLE'S ESC BEFORE CHARGING MAY PERMANENTLY DAMAGE SOME OR ALL ELECTRONICS IN THE VEHICLE.

NEVER LEAVE BATTERY PACKS UNATTENDED WHILE CHARGING! Leaving a battery unattended while charging may result in fire and damage / injury.

NEVER ALLOW A BATTERY PACK TO GET HOT! It's normal for the battery pack to get warm, but it should never get hot! Monitor batteries during charging and unplug to let cool if the battery gets hot.

WHEN CHARGING LIPOs, A LIPO SAFE CHARGING BAG SHOULD BE USED TO HELP PREVENT FIRES.

Volcano EPX
EXPLODED VIEW

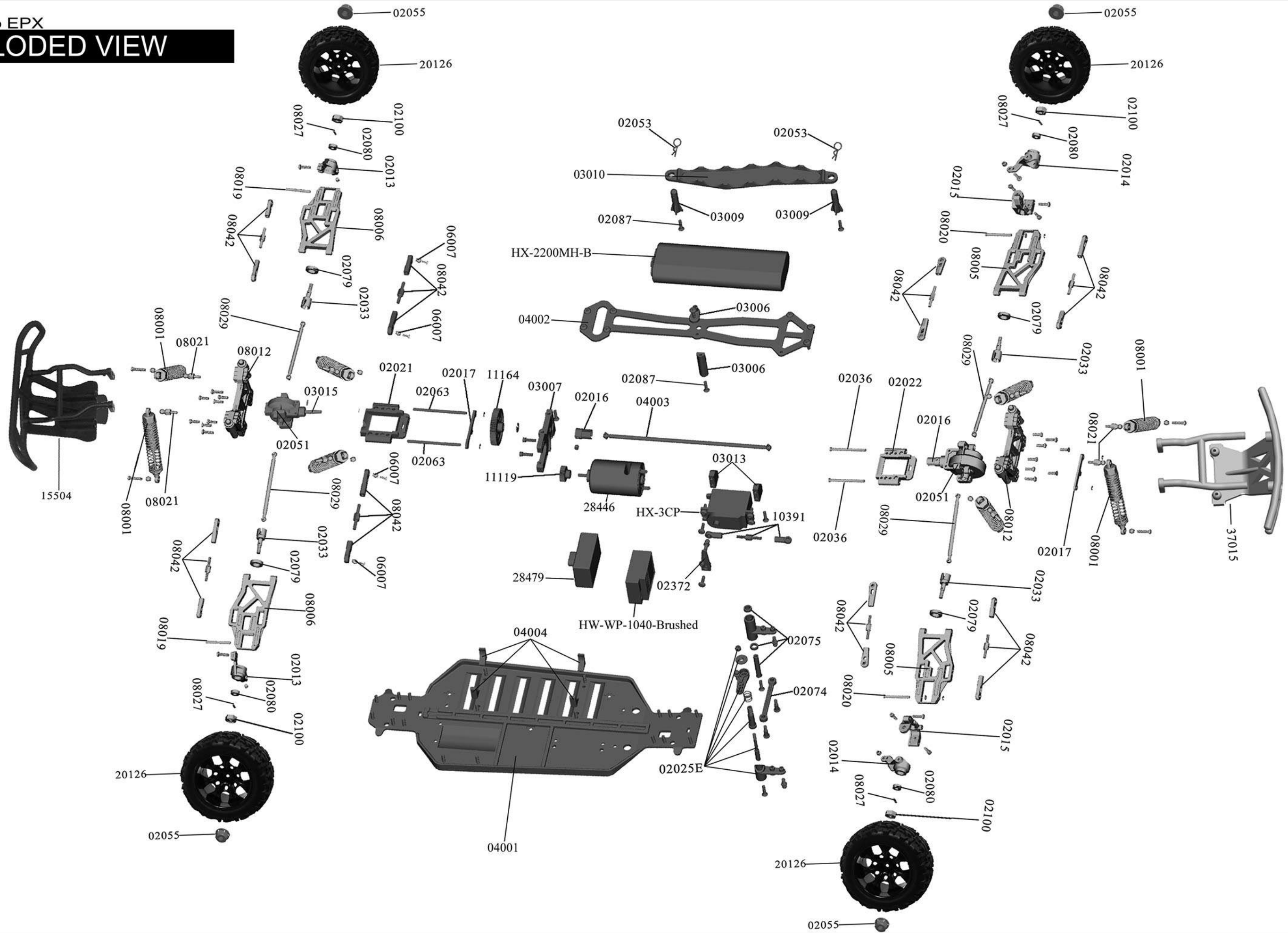

EXPLODED VIEWS

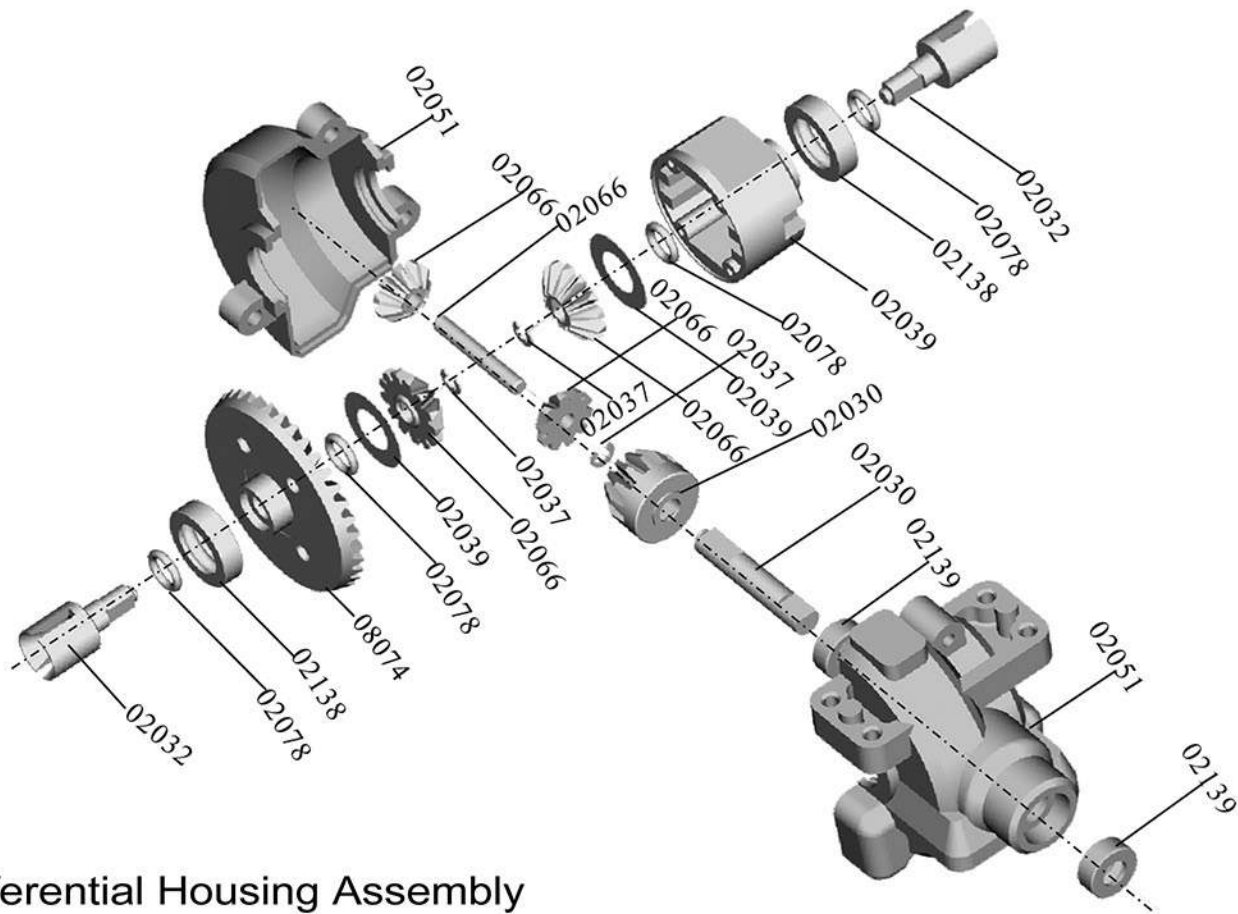

Differential Housing Assembly

































PARTS IDENTIFICATION

<p>08005- Front Lower Suspension Arm</p> 	<p>08006- Rear Lower Suspension Arm</p> 	<p>02014-Steering Hubs (L/R)</p> 	<p>02015-Front Hub Carrier(L/R)</p> 	<p>02013-Rear Upright+ Set Screws</p> 
<p>02033-Wheel Axle</p> 	<p>02016-Universal Joint Cup B+ GrubScrew</p> 	<p>02032-Universal Joint Cup C</p> 	<p>02021-Rear Suspension Arm Holder</p> 	<p>02022-Front Suspension Arm Holder</p> 
<p>08002- Front Bumper</p> 	<p>08003-Rear Bumper</p> 	<p>08012- Fron/Rear Shock Tower</p> 	<p>08001-Shock Absorber</p> 	<p>28446-Motor (Rc550)</p> 





































PARTS IDENTIFICATION

02500-Motor Wire + Capacitors 	03007-Motor Mount 	04001-Chassis 	04002-Upper Chassis Brace 	03013-Radio Tray Mounts 
03010-Battery Strap 	HX-2200MH-B 7.2V NiMH Battery 	04004-Corner Battery Mounts 	03009-Battery Cover post 	02074-Steering Joint 
02025E-Servo Saver Set 	02075-Steering Assembly B 	03401-Gear Cover 	03300-Motor Heat Sink 	11164-Spur Gear (64T) 
11119-Pinion Gear (17T) 	08074-Crown Gear (38T) (Copper infiltration) 	02030-Drive Gear 	02024-Diff.Gear Complete 	03015-Drive Shaft+E-Clip 
02066-Diff.Planetary Gears + Pin 	02039-Differential Box (W/ 2 Shims + Washers) 	02051-Gear Box 	10391-Servo Link 	08042-Front/Rear Link 
08007- Body Post 	08029-Dogbones 90mm Front/Rear qty 2 	08027- Pin 2*10 	08019- Rear Lower Arm Pin B 3*30mm 	08020- Front Lower Arm Pin B 3*33mm 
02036-Front Lower Arm Pins A 3*44mm 	02063-Rear Lower Arm Pin A 3*54mm 	04003-Center Dogbone 	02057-Antenna Pipe 	03006-Antenna Mount 
02372-Servo Arm 	02017-Suspension Reinforcement Brace 	08008N-Wheel Rim 	20126-Wheel/Tire Set qty 2 	02053-R- Clip 

PARTS IDENTIFICATION

02096-3*10 Cap Head Machine Screw 6P 	02097-Cap Head Machine Screw 3*14 6P 	08024- Washer Screw M3*11 8P 	02083-Cap Head Self-Tapping Screw 3*12 6P 	02081-Cap Head Self-Tapping Screw 3*8 6P 
02101- Steering Bushing 	02082-Cap Head Self-Tapping Screw 3*10 10P 	02100- Wheel Hex. 	02085-Round Head Self-Tapping Screw 2*8 8P 	02037-E-Clip (Ø7Ø4Ø2.5Ø2.3) 
02139-Ball Bearing 10*5*4 	02138-Ball Bearing 15*10*4 	02078-Differential O-Ring 	02079-Bushing 15*10*4 	02080-Bushing 5*10*4 
06007-Shock Swivel Ball Insert 	02055-M4 Nylon Lock Nut 	02102- M3 Nylon Lock Nut 	08021- Upper Shock Ball Studs 	01083-Round Head Machine Screw 3*11 6P 
06023-Shock Ball Studs B Female Thread 	02038-Ball Studs 	02099- Grub Screw M4*4 	02098- Grub Screw M3*4 	02127-M3*14 Grub Hex. Screw 10P 
02087-Countersunk Cross Head Self-Tapping Screw 3*10 15P 	02088-Countersunk Cross Head Self-Tapping Screw 3*14 13P 	02089-Countersunk Cross Head Self-Tapping Screw 3*15 9P 	02086-Round Head Self-Tapping Screw 2*10 10P 	02092-ISO 3*10 Screw 8P 
81220-5-Flat Head Machine Screw 3*14 4P 	02095-M3*8 Column Head Machine Screw 4P 	02093-M3*10 Column Head Machine Screw 10P 		

OPTIONAL PERFORMANCE PARTS

<p>08041-Aluminum Shock Absorber</p> 	<p>03302-Brushless Motor KV:3300</p> 	<p>03404-Brushless Motor KV:2724</p> 	<p>02191B-Aluminum Lock Nut M3 (Blue)</p> 	<p>102049-Aluminum Nut M4</p> 
<p>11184-Diff. MainGear (64T) Metal</p> 	<p>11188-Diff.Main Gear (48T)</p> 	<p>11185-Pinion Gear(15T)</p> 	<p>11149-Pinion Gear Metal (19T)</p> 	<p>11181-Pinion Gear Metal (21T)</p> 
<p>HX-3800MH-B 7.2V NiMH Battery 3800mAh</p> 	<p>HX-5000MH-B 7.2V NiMH Battery 5000mAh</p> 	<p>102040-Aluminum Ackerman Plate</p> 	<p>102260-Aluminum Front Gear Box Mount</p> 	<p>103013-Servo Mount(AL.) +Flat Head Machine Screw 3*8*2P+Cap Head Machine Screw 3*8* 4P</p> 
<p>02132P-Aluminum Front Hub Carrier(L/R) +Flat Head Machine Screws 3*15mm*2P</p> 	<p>02131P-Steering Hub (L/R)(AL.)+Cap Head Machine Screws 3*12* 2P/3*11mm*2P</p> 	<p>02130P-Aluminum Rear Hub Carrier(L/R)+Flat Head Machine Screws 3*15mm*2P+M4*4 Grub Hex. Screw 2P</p> 	<p>02134-Aluminum Wheel Hex</p> 	<p>02191P-Aluminum Nut M3 (Purple)</p> 
<p>102049-Aluminum Nut M4</p> 	<p>06048-Front & Rear Servo Link (AL) + Flat Head Machine Screws 3*14mm*4P + Nut M3*4P</p> 	<p>08046-Universal Drive Joint</p> 	<p>08055-Front Lower Arm (AL) + Flat Head Machine Screws 3*10*4P</p> 	<p>08056-Rear Lower Arm (AL) + Flat Head Machine Screws 3*10*4P</p> 
<p>08054-Aluminum Shock Tower + Cap Head Machine Screws 3*12*2P</p> 	<p>08047-Aluminum Body Posts</p> 	<p>103009-Aluminum Battery Posts+Flat Head Machine3*10*2P</p> 	<p>102057-Aluminum Servo Saver Set</p> 	<p>108835-Aluminum Front Brace+Cap Head Machine Screws 3*8mm *6P</p> 
<p>HUK-1B -Aluminum Hop-Up Kit (Blue)</p> 	<p>HUK-1P -Aluminum Hop-Up Kit (Purple)</p> 	<p>103071-Motor Brace (AL.)+Flat Head Machine Screw 3*8*4P/ Cap Head Machine Screw 3*8*2P</p> 	<p>107001-Carbon Fibre Chassis</p> 	<p>108836-Aluminum Rear Brace+Cap Head Machine Screws 3*8mm * 4P/3*10mm*2P</p> 
		<p>102261-Aluminum Rear Gear Box Mount</p> 	<p>102227-Suspension Arm Brace(AL.)</p> 	



FAST  AFFORDABLE  FUN

www.redcatracing.com

 Follow us on FaceBook: <https://www.facebook.com/RedcatRacing>

MAN-VOLCANOEPX-2017-2-10

- To ensure that you are using the most recent version of this manual:
www.redcatracing.com/manuals/VOLCANOEPXMANUAL.pdf
- To ensure that you have the most recent version of the Electric Vehicles Manual:
www.redcatracing.com/manuals/ELECTRIC-MANUAL.pdf