



DX9

9-Channel 2.4GHz DSMX® Aircraft System

Instruction Manual
Bedienungsanleitung
Manuel d'utilisation
Manuale di Istruzioni
Manual de instrucciones



Bind-N-Fly® Ready to fly, redefined.



9-CHANNEL DSMX® TELEMETRY SYSTEM

DSMX (50) Tx 7.9V

3: Splendor

TM1 2:53



Spektrum

3 MODEL TYPES WIRELESS TRAINER VOICE ALERTS

NOTICE

All instructions, warranties and other collateral documents are subject to change at the sole discretion of Horizon Hobby, Inc. For up-to-date product literature, visit horizonhobby.com and click on the support tab for this product.

Meaning of Special Language

The following terms are used throughout the product literature to indicate various levels of potential harm when operating this product:

NOTICE: Procedures, which if not properly followed, create a possibility of physical property damage AND little or no possibility of injury.

CAUTION: Procedures, which if not properly followed, create the probability of physical property damage AND a possibility of serious injury.

WARNING: Procedures, which if not properly followed, create the probability of property damage, collateral damage and serious injury OR create a high probability of superficial injury.



WARNING: Read the ENTIRE instruction manual to become familiar with the features of the product before operating.

Failure to operate the product correctly can result in damage to the product, personal property and cause serious injury.

This is a sophisticated hobby product. It must be operated with caution and common sense and requires some basic mechanical ability. Failure to operate this Product in a safe and responsible manner could result in injury or damage to the product or other property. This product is not intended for use by children without direct adult supervision. Do not attempt disassembly, use with incompatible components or augment product in any way without the approval of Horizon Hobby, Inc. This manual contains instructions for safety, operation and maintenance. It is essential to read and follow all the instructions and warnings in the manual, prior to assembly, setup or use, in order to operate correctly and avoid damage or serious injury.



WARNING AGAINST COUNTERFEIT PRODUCTS

Always purchase from a Horizon Hobby, Inc. authorized dealer to ensure authentic high-quality Spektrum product. Horizon Hobby, Inc. disclaims all support and warranty with regards, but not limited to, compatibility and performance of counterfeit products or products claiming compatibility with DSM or Spektrum.

NOTICE: This product is only intended for use with unmanned, hobby-grade, remote-controlled vehicles and aircraft. Horizon Hobby disclaims all liability outside of the intended purpose and will not provide warranty service related thereto.

Age Recommendation: Not for Children under 14 years. This is not a toy.

Warranty Registration

Visit spektrumrc.com today to register your product.

NOTICE: While DSMX allows you to use more than 40 transmitters simultaneously, when using DSM2 receivers, DSMX receivers in DSM2 mode or transmitters in DSM2 mode, do not use more than 40 transmitters simultaneously.

General Notes

- Models are hazardous when operated and maintained incorrectly.
- Always install and operate a radio control system correctly.
- Always pilot a model so the model is kept under control in all conditions.
- Please seek help from an experienced pilot or your local hobby store.
- Contact local or regional modeling organizations for guidance and instructions about flying in your area.
- When working with a model, always power on the transmitter first and power off the transmitter last.
- After a model is bound to a transmitter and the model is set up in the transmitter, always bind the model to the transmitter again to establish failsafe settings.

Pilot Safety

- Always make sure all batteries are fully charged before flying.
- Time flights so you can fly safely within the time allotted by your battery.
- Perform a range check of the transmitter and the model before flying the model.
- Make sure all control surfaces correctly respond to transmitter controls before flying.
- Do NOT fly a model near spectators, parking areas or any other area that could result in injury to people or damage to property.
- Do NOT fly during adverse weather conditions. Poor visibility, wind, moisture and ice can cause pilot disorientation and/or loss of control of a model.
- When a flying model does not respond correctly to controls, land the model and correct the cause of the problem.

DX9 Features

- “Roll” between telemetry, monitor and main screens without entering the Settings menu
- Switch between Function List and System Settings menus without powering off the transmitter
- Voice alerts for telemetry, warnings, and other conditions
- Selectable sound menu lets you activate or inhibit specific DX9 sounds
- Assign five Airplane flight modes to any combination of up to two switches
- Virtually Unlimited Model Memory (250 models)
- Assign in-flight aircraft gyro gain adjustment to one of the side levers, the right knob, or one of the auxiliary trim switches at the top of the transmitter faceplate
- Pitch curve for Airplane models with variable pitch props
- Wireless trainer



BEFORE USING YOUR TRANSMITTER:

Before going any further, visit the Spektrum Community website at spektrumrc.com to register your transmitter and download the latest AirWare™ firmware updates. A registration reminder screen occasionally appears until you register your transmitter. When you register your transmitter, the reminder screen does not appear again.

Box Contents

- DX9 Transmitter
- 2000mAh Li-Ion Transmitter Pack (Installed in transmitter)
- Global Power Supply
- SD card
- Neck strap
- Decal sheet
- Manual

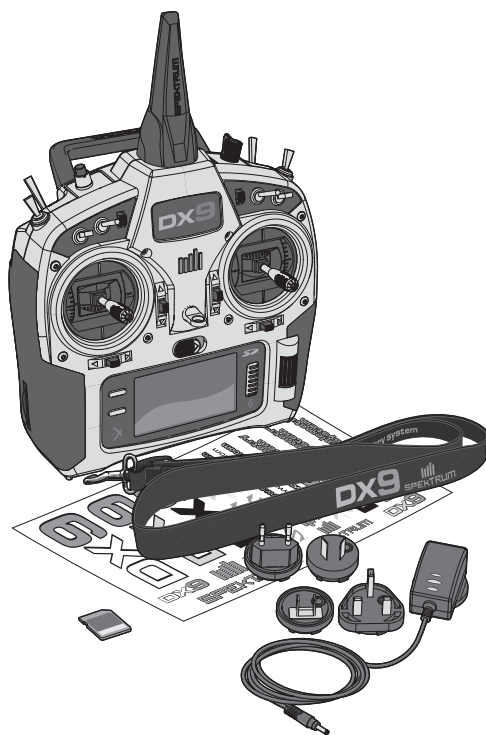

Table of Contents

Transmitter Batteries	5	Travel Adjust	25
Charging Your Transmitter	5	Sub-Trim	25
Transmitter Functions	6	Reverse	25
Main Screen	8	Function List	25
Navigation	8	D/R & Exponential	26
Auto Switch Select	8	Speed	26
SD Card	9	Absolute (Abs.) Travel	26
Installing the SD Card	9	Balance	26
Exporting the Transmitter Serial Number to the SD Card	9	Differential (Air and Sail Types only)	26
Power System Requirements	9	V-Tail Differential (Air and Sail Types only)	27
Binding	10	Throttle Cut	27
Binding Using the Receiver and Receiver Battery	10	Throttle Curve	27
Binding Using the Receiver and ESC	10	Mixing	28
Programming Failsafe Positions	11	Offset	28
SmartSafe™ Failsafe	11	Trim	28
Hold Last Command	11	Assigning a Mix to a Switch	28
Preset Failsafe	11	Back Mixing	28
Model Type Programming Guide	12	Sequencer	29
Common System Setup Functions	13	Sequencer SetUp	29
Model Select.....	13	System Sounds	30
Model Type	13	Range Test.....	30
Model Name	13	Timer	30
F-Mode Setup.....	14	Telemetry	30
Aircraft and Sailplane Flight Mode Table	14	System Setup	31
Spoken Flight Mode Setup	14	Monitor.....	31
Channel Assignment.....	15	ACRO (Airplane)	32
Channel Input Configuration.....	15	Recommended Servo Connections	32
Trim Setup.....	15	Elevon Servo Control	33
Model Utilities	16	Flap System.....	33
Create New Model.....	16	ACRO Mixing	33
Delete Model	16	Acro Gyro Function	34
Copy Model	16	Pitch Curve Function	34
Model Reset	16	Swash Type	35
Sort Model List.....	16	Collective Type	35
Warnings	17	Pitch Curve.....	35
Telemetry	17	HELI (Helicopter)	35
Telemetry Auto-Configuration	17	Swashplate.....	36
Telemetry Alarms	18	Gyro	36
Preflight Setup	18	Governor	36
Frame Rate.....	18	Tail Curve	37
Bind	18	Mixing	37
Trainer	19	SAIL (Sailplane)	38
Wired Trainer	19	Camber Preset.....	38
Wireless Trainer	20	Camber System	38
System Settings	21	SAIL Mixing	39
User Name	21	Physical Transmitter Adjustments	40
Contrast	21	Transmitter Mode Conversion	40
Backlight	21	Mechanical Conversion.....	40
Mode	21	Adjust Throttle Friction Straps	42
Battery Alarm.....	21	Adjusting the Throttle Ratchet Strap	42
Selecting a Language.....	22	Control Stick Length Adjustment	42
Inactive Alarm	22	Adjust Stick Tension	42
Extra Settings	22	Troubleshooting Guide	43
System Sounds.....	22	1-Year Limited Warranty	44
Vibrator	22	Warranty and Service Contact Information	45
Trim Display.....	22	FCC Information	45
Serial Number.....	23	Antenna Separation Distance	45
Calibrate.....	23	IC Information	45
Transfer SD Card	24	FAA Information	45
Import Model	24	Compliance Information for the European Union	46
Export Model	24	Declaration of Conformity	46
Updating Spektrum DX9 Sound Files	24	Instructions for disposal of WEEE	46
Update AirWare Software	25	Replacement Parts	223
Servo Setup	25		

Transmitter Batteries

Battery and Charging Precautions and Warnings

Failure to exercise caution while using this product and comply with the following warnings could result in product malfunction, electrical issues, excessive heat, FIRE, and ultimately injury and property damage.

- Read all safety precautions and literature prior to use of this product
- **Never** allow minors to charge battery packs
- **Never** drop charger or batteries
- **Never** attempt to charge damaged batteries
- **Never** attempt to charge a battery pack containing different types of batteries
- **Never** charge a battery if the cable has been pinched or shorted
- **Never** allow batteries or battery packs to come into contact with moisture at any time
- **Never** charge batteries in extremely hot or cold places (recommended between 50–80 degrees F or 10–27 degrees C) or place in direct sunlight
- **Always** disconnect the battery after charging, and let the charger cool between charges
- **Always** inspect a new battery before charging
- **Always** terminate all processes and contact Horizon Hobby if the product malfunctions
- **Always** keep batteries and charger away from any material that could be affected by heat (such as ceramic and tile), as they can get hot
- **Always** end the charging process if the charger or battery becomes hot to the touch or starts to change form (swell) during the charge process

Charging Your Transmitter

The DX9 has an internal charger designed to charge the included 2-cell Li-Ion battery at a charge rate of 200mAh. The charge port on the right side of the transmitter is not polarity-dependent.

NOTICE: Never connect an external battery charger to your DX9 transmitter. If you wish to charge the Li-Ion battery using a Lipo/Li-Ion charger, you must remove the battery from the transmitter before charging.

The first time you charge the transmitter battery, the charge time may be 12–15 hours. Always charge the transmitter on a heat-resistant surface.

1. Power off your transmitter.
2. Connect the power supply connector to the transmitter charge port.
3. Connect the power supply to a power outlet using the appropriate adapter.
4. The blue LED on the front of the transmitter turns on during charging and turns off when the battery is fully charged.
5. Disconnect the transmitter from the power supply once charging is complete and disconnect the power supply from the power outlet.



CAUTION: Never leave a charging battery unattended.

LED indicators

The blue LED indicates the transmitter battery is charging. The orange LED indicates the transmitter is powered on and there is radio transmission.

Battery Alarm

The System Settings Screen allows you to change the battery type and low alarm settings. See “System Settings” for more information.

- An alarm will sound when the battery reaches the low voltage limit (4.3V for NiMH, 6.4V for LiPo/Li-Ion).



CAUTION: Never change the low voltage limit for LiPo/Li-Ion batteries from 6.4V. Doing so could over-discharge the battery and damage both battery and transmitter.

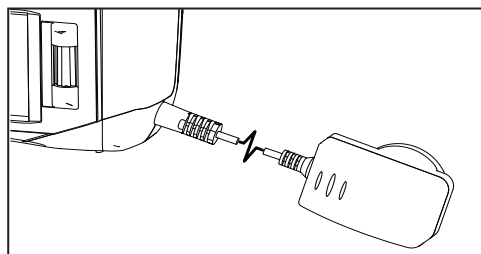

Transmitter Functions

Function	
①	Antenna 1
②	Right Trim
③	Right Knob
④	Switch E
⑤	Switch H
⑥	Switch G
⑦	Switch F
⑧	Throttle/Aileron Stick (Mode 1) Elevator/Aileron Stick (Mode 2) Throttle/Rudder Stick (Mode 3) Elevator/Rudder Stick (Mode 4)

Function	
⑨	Elevator Trim (Mode 2, 4) Throttle Trim (Mode 1, 3)
⑩	Aileron Trim (Mode 1,2) Rudder Trim (Mode 3,4)
⑪	Roller
⑫	Charge Port
⑬	Speaker Grill
⑭	On/Off Switch
⑮	LCD
⑯	Clear Button
⑰	Back Button
⑱	SD Card Slot
⑲	Neck Strap Mount

Function	
⑳	Rudder Trim (Mode 1,2) Aileron Trim (Mode 3,4)
㉑	Elevator Trim (Mode 1,3) Throttle Trim (Mode 2,4)
㉒	Elevator/Rudder Stick (Mode 1) Throttle/Rudder Stick (Mode 2) Elevator/Aileron Stick (Mode 3) Throttle/Aileron Stick (Mode 4)
㉓	Switch C
㉔	Switch B
㉕	Switch A

Function	
㉖	Switch D
㉗	Bind/Switch I
㉘	Left Trim
㉙	LED

The transmitter comes with a thin, clear plastic film applied to some front panels for protection during shipping. Humidity and use may cause this film to come off. Carefully remove this film as desired.

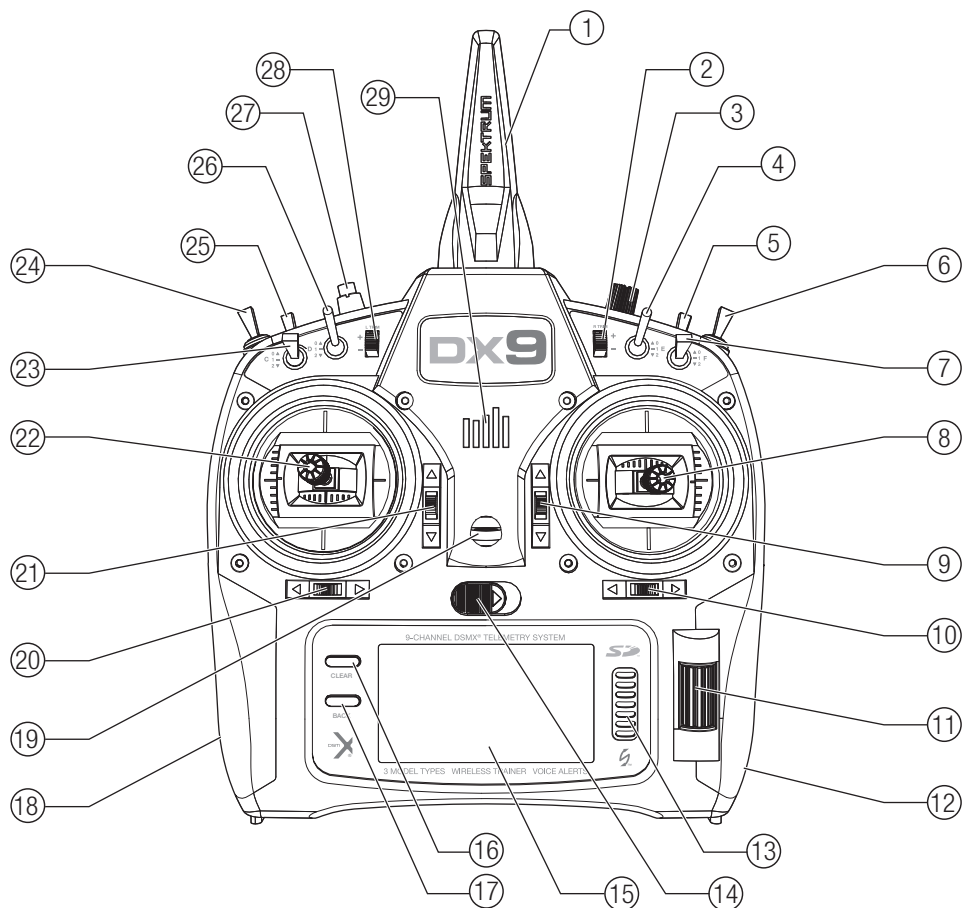

Transmitter Functions

Function	
①	Handle/Antenna 2
②	Throttle Spring Tension Adjustment (<i>Mode 2,4</i>)
③	Left Lever
④	Gimbal Stick Tension Adjustment
⑤	Mode Change

Function	
⑥	Left Rear Grip
⑦	SD Card
⑧	Audio Jack
⑨	Battery Cover
⑩	Trainer Port
⑪	Charge Port

Function	
⑫	Right Rear Grip
⑬	Gimbal Stick Tension Adjustment
⑭	Mode Change
⑮	Right Lever
⑯	Throttle Spring Tension Adjustment (<i>Mode 1,3</i>)

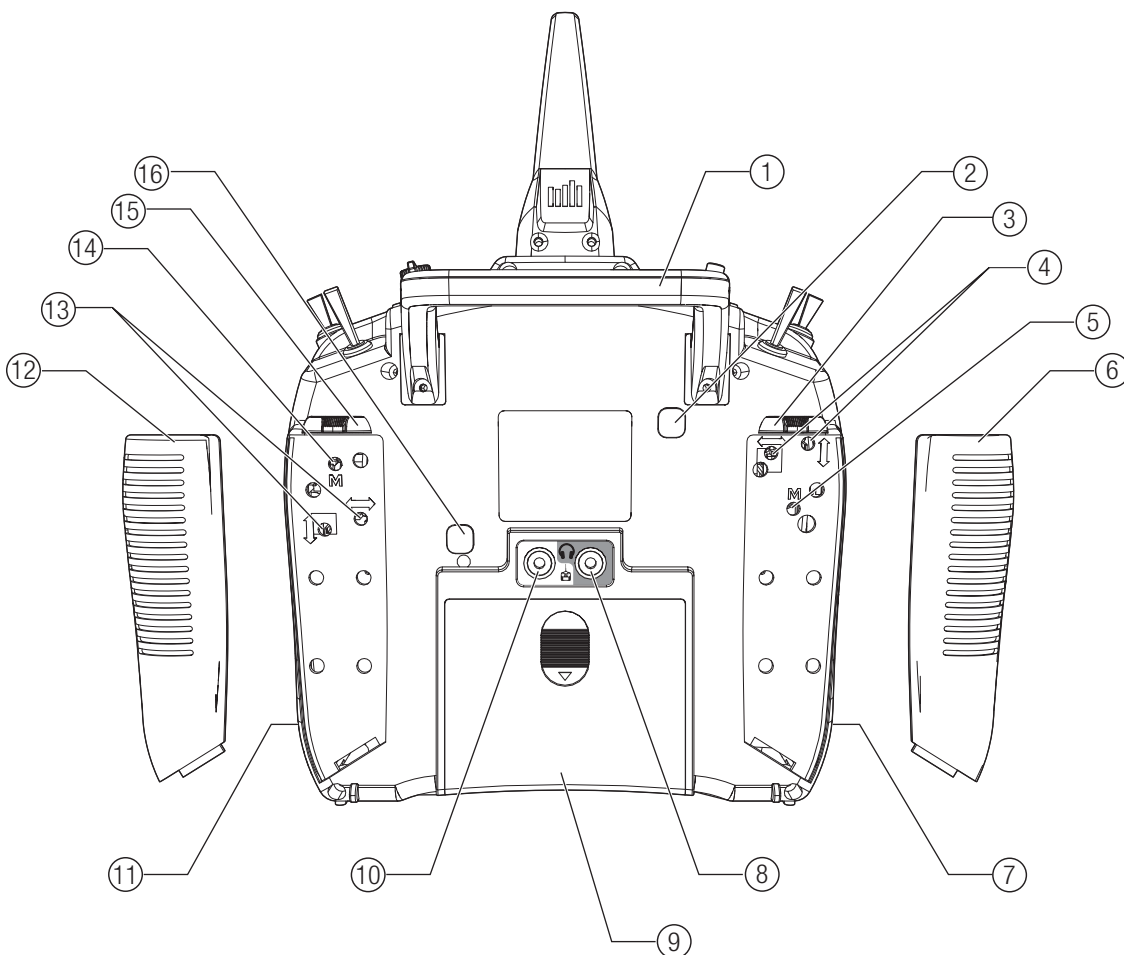

Main Screen

Function	
(A)	Model Name
(B)	DSMX/DSM2 If not shown, this indicates "not bound".
(C)	Transmitter Battery Charge Level Also displays the Volume Level when the BACK button is pressed
(D)	Digital Battery Voltage <i>(an alarm sounds and the screen flashes when battery charge gets down to 4.3V when using an NiMH battery or 6.4V for a LiPo/Li Ion battery.)</i>
(E)	Model Type
(F)	Elevator Trim <i>(Modes 2 and 4)</i> Throttle Trim <i>(Modes 1 and 3)</i> Also displays R Trim values when the Right Trim button is pressed
(G)	Aileron Trim <i>(Modes 1 and 2)</i> Rudder Trim <i>(Modes 3 and 4)</i>
(H)	Model Memory Timer

Function	
(I)	Rudder Trim <i>(Modes 1 and 2)</i> Aileron Trim <i>(Modes 3 and 4)</i> Also displays L Trim values when the Left Trim button is pressed
(J)	Throttle Trim <i>(Mode 2 and 4)</i> Elevator Trim <i>(Mode 1 and 3)</i>
(K)	Timer

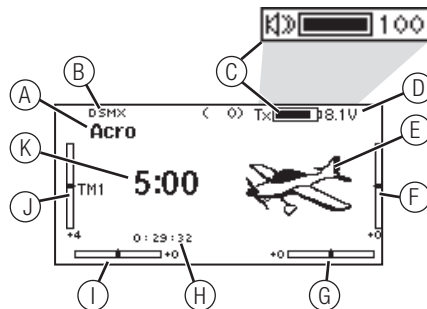

Navigation

- Turn the scroll wheel to move through the screen content or change programming values. Press the scroll wheel to make a selection.
- Use the Back button to go to the previous screen (for example, to go from the Mixing Screen to the Function List).
- Use the Clear button to return a selected value on a screen to the default setting.
- Direct Model Access enables you to access the Model Select screen without powering off the transmitter. Anytime the transmitter power is on, press the Clear and Back buttons to access the Model Select screen.
- Press and hold the roller while powering on the transmitter to show the System Setup list. No radio transmission occurs when a System Setup screen is displayed, preventing accidental damage to linkages and servos during changes to programming.
- At the main screen you can roll the roller to view the servo monitor.
- The Main Screen appears when you power on the transmitter. Press the scroll wheel once to display the Function List.
- When you want to change a value in a screen for a particular control position, move the control to the desired position to highlight the value you want to change, such as 0/1/2, up/down or left/right.



Press
Enter, Choose
or Exit

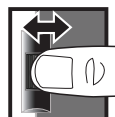

Turn
Move between
options or change
value in an option



Hold
Hold for 3
seconds and
release to move to
the Main Screen

Tip: The tick mark below shows the current switch position. Rolling and clicking the roller turns the selected box black, indicating that the value or condition will act on that position.

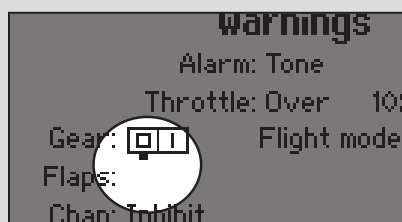

Auto Switch Select

To easily select a switch in a function, such as a program mix, roll with the roller to highlight the switch selection box, and press the roller. The box around the switch should now flash. To select a switch, toggle the switch you wish to select. Verify the switch selection is now displayed as desired. When correct, press the roller to select this switch and complete the switch selection.

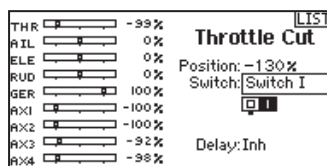

SD CARD

Installing the SD Card

The included SD Card enables you to:

- Import (copy) models from another DX9 transmitter
- Export (transfer) models to another DX9 transmitter
- Update AirWare™ software in the transmitter
- Install/Update sound files

To install the SD Card:

1. Power off the transmitter.
2. Press the SD Card into the card slot with the card label facing upward.

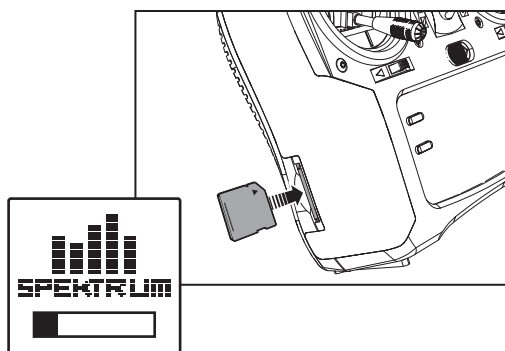

Exporting the Transmitter Serial Number to the SD Card

Exporting the transmitter serial number to the SD Card allows you to copy and paste the serial number into the registration screen at spektrumrc.com.

To export the serial number:

1. Press and hold the scroll wheel while powering the transmitter on until the System Setup list appears.
2. Scroll to the System Settings menu. Press the scroll wheel once to open the menu.
3. Select **NEXT** on the System Settings and Extra Settings screens.
4. When the Serial Number screen appears, select **EXPORT**.
5. Power off the transmitter and remove the SD Card from the transmitter.
6. Insert the SD Card in your computer and open the My_DX9.xml file on the card.
7. Import My_DX9.xml into the Registration screen on the Spektrum Community site (spektrumrc.com).

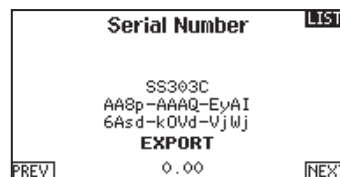

Power System Requirements

Inadequate power systems that do not provide the necessary minimum voltage to the receiver during flight are the number one cause of in-flight failures. Some of the power system components that affect the ability to properly deliver adequate power include:

- Receiver battery pack (number of cells, capacity, cell type, state of charge)
- The ESC's capability to deliver current to the receiver in electric aircraft
- The switch harness, battery leads, servo leads, regulators, etc.

Recommended Power System Test Guidelines

If a questionable power system is being used (e.g., a small or old battery, an ESC that may not have a BEC that will support high-current draw, etc.), perform the following test with a voltmeter. The *Hangar 9*® Digital Servo & Rx Current Meter (HAN172) or the *Spektrum* Flight Log (SPM9540) work well for this test.

Plug the voltmeter into an open channel port in the receiver and, with the system on, load the control surfaces (apply pressure with your hand) while monitoring the voltage at the receiver. The voltage should remain above 4.8 volts even when all servos are heavily loaded.

CAUTION: When charging Ni-MH batteries, make sure the battery fully charges. Ni-MH batteries charged with peak detection fast chargers have a tendency to false peak (i.e. not fully charge), which could lead to a crash.

BINDING

Binding is the process of programming the receiver to recognize the GUID (Globally Unique Identifier) code of a single specific transmitter. You will need to rebind after the model programming is initially set up to fully program the model's failsafe positions.

Binding Using the Receiver and Receiver Battery

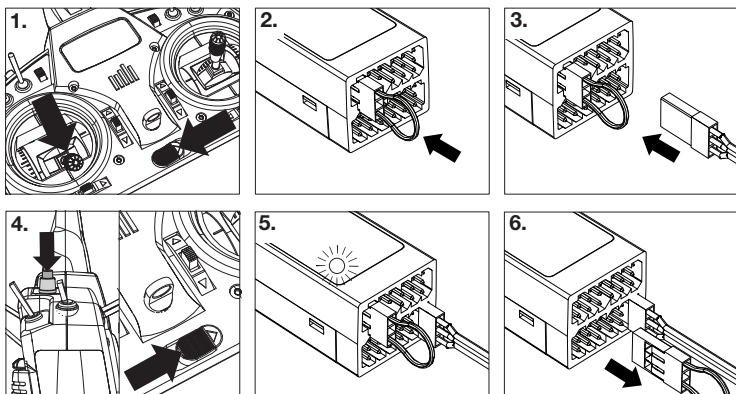

1. Lower throttle to the lowest position and make sure the transmitter is powered off.
2. Insert the bind plug into the BIND/DATA port.
3. Insert the receiver battery into any open port. The receiver's LED will flash when the receiver is ready to bind.

4. While pressing the Bind button, power on the transmitter.
5. Release the Bind button after the receiver has stopped flashing rapidly, once the receiver's LED stays illuminated; this indicates the receiver is bound to the transmitter. The screen also provides binding information.
6. Remove the bind plug from the receiver.

Binding Using the Receiver and ESC

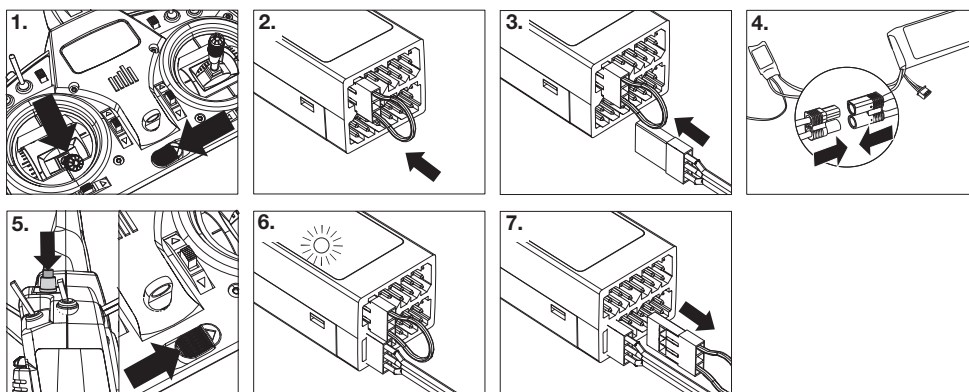

1. Lower throttle to the lowest position and make sure the transmitter is powered off.
2. Insert the bind plug into the BIND/DATA port.
3. Insert the ESC plug into the THRO port.
4. Connect battery to ESC and turn on ESC switch, if available. The receiver's LED will rapidly flash when the receiver is ready to bind.

5. While pressing the Bind button, power on the transmitter.
6. Release the Bind button after the receiver has stopped flashing rapidly, once the receiver's LED stays illuminated; this indicates the receiver is bound to the transmitter. The screen also provides binding information.
7. Remove the bind plug from the receiver.

PROGRAMMING FAILSAFE POSITIONS

You establish failsafe positions when you bind your transmitter and receiver. If the radio signal connection is lost between the transmitter and receiver, the receiver immediately moves the aircraft control surfaces to the failsafe positions. If you assign the receiver THRO channel to a transmitter channel other than throttle, we recommend using Preset failsafe with the throttle in the low position.

NOTICE: Failsafe features vary according to receiver. Always consult the receiver instruction manual for failsafe features.

Before flight, ALWAYS confirm the failsafe functions as you would expect.

SmartSafe™ Failsafe

SmartSafe failsafe is a technology that only acts on the throttle channel and offers the following benefits:

- Prevents electric motors from operating when the receiver power is on and the transmitter power is off.
- Prevents the speed controller from arming until the throttle is moved to the low throttle position.
- Powers off an electric motor and reduces gas/glow engines to idle if signal is lost.

To Program SmartSafe, move the throttle to the low or off position before putting the transmitter into bind mode.

To Test the SmartSafe failsafe

1. Power the transmitter and receiver on.
2. Power off the transmitter. The throttle should immediately move to the failsafe position.



CAUTION: Make sure the aircraft is fully restrained on the ground. If the failsafe is not set correctly, your aircraft might advance to mid or full throttle.

Hold Last Command

The Hold Last Command failsafe maintains the last command on all channels except throttle. If the radio signal is lost, the aircraft maintains the commanded heading until the receiver regains signal. To program Hold Last Command, follow the provided binding instructions in this instruction manual.

To Test Hold Last Command:

1. Power on the transmitter and receiver.
2. Move one of the control sticks to the desired Hold Last Command position and hold the input.
3. While holding the control input (for example, a small amount of rudder) power off the transmitter. The rudder should maintain the input command.



CAUTION: Make sure the aircraft is fully restrained on the ground. If the failsafe is not set correctly, the aircraft throttle might advance to mid or full throttle.

Preset Failsafe

The Preset failsafe moves all channels to their programmed failsafe positions.

We recommend using Preset failsafe to deploy spoilers on sailplanes to prevent a flyaway if the radio signal is lost.

To program Preset failsafe:

1. Insert the bind plug in the bind port on the receiver and power on the receiver.
2. Remove the bind plug when the orange LED on the main receiver and all attached remote receivers flash rapidly. The orange receiver LEDs will continue flashing.
3. Move the transmitter control sticks and switches to the desired Preset failsafe position. Power the transmitter on.
4. Failsafe programming is complete when the orange LEDs on the transmitter and all receivers turn solid.



CAUTION: Make sure the aircraft is fully restrained on the ground. If the failsafe is not set correctly, the aircraft throttle might advance to mid or full throttle.

MODEL TYPE PROGRAMMING GUIDE

Menu options show up on model type selection. These menu options vary between Model Types (Airplane, Helicopter and Sailplane), but are identical for all models in that type. Subsequent aircraft type (Aircraft, Swashplate or Sailplane) selections make other menu options appear.



System Setup List:	Function List:
Model Select	Servo Setup
Model Type	D/R and Expo
Model Name	Throttle Cut
Aircraft Type	Throttle Curve
F-Mode Setup	→ Gyro1
Spoken Flight Mode	→ Gyro2
Channel Assign	→ Gyro3
Trim Setup	→ Pitch Curve
Model Utilities	→ Flap System
Warnings	Mixing
Telemetry	Sequencer
Preflight Setup	Range Test
Frame Rate	Timer
Bind	Telemetry
Trainer	Custom Voice Setup
System Settings	System Setup
Transfer SD Card	Monitor



System Setup List:	Function List:
Model Select	Servo Setup
Model Type	D/R and Expo
Model Name	→ Differential
Sailplane Type	→ U-Tail Differential
F-Mode Setup	→ Throttle Cut
Spoken Flight Mode	→ Motor Curve
Channel Assign	→ Camber Presets
Trim Setup	→ Camber System
Model Utilities	Mixing
Warnings	Sequencer
Telemetry	Range Test
Preflight Setup	Timer
Frame Rate	Telemetry
Bind	Custom Voice Setup
Trainer	System Setup
System Settings	Monitor
Transfer SD Card	



System Setup List:	Function List:
Model Select	Servo Setup
Model Type	D/R and Expo
Model Name	Throttle Cut
Swashplate Type	Throttle Curve
F-Mode Setup	Pitch Curve
Spoken Flight Mode	→ Swashplate
Channel Assign	Gyro
Trim Setup	Governor
Model Utilities	Tail Curve
Warnings	Mixing
Telemetry	Sequencer
Preflight Setup	Range Test
Frame Rate	Timer
Bind	Telemetry
Trainer	Custom Voice Setup
System Settings	System Setup
Transfer SD Card	Monitor

COMMON SYSTEM SETUP FUNCTIONS

Model Select

Model Select enables you to access any of the 250 internal model memory locations in the Model Select list.

1. Scroll to the desired model memory in the Model Select list.
2. When the desired model memory is highlighted, press the scroll wheel once to select the model. The transmitter returns to the System Setup List.
3. Add a new model by rolling to the bottom of the list. You will then be prompted with the Create New Model screen, with the option to create a new model or cancel. If you select Cancel the system will return to the Model Select function. If you select Create, the new model will be created and now be available in the model select list.

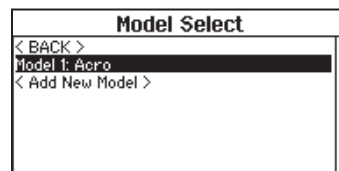

Direct Model Access

Press the Clear and Back buttons from the Main Screen or a telemetry screen to access Model Select.

Model Type

Select from Airplane, Helicopter or Sailplane model types.

IMPORTANT: When you select a new model type, you will delete any programming data in the current model memory. Always confirm the desired model memory before changing model types. It will be necessary to re-bind after resetting the model type.

To change the model type:

1. Scroll to the desired model type and press the scroll wheel. The Confirm Model Type screen appears.
2. Select Yes and press the scroll wheel to confirm the model type. All data will be reset. Selecting No will exit the Confirm Model Type screen and return to the Model Type screen.

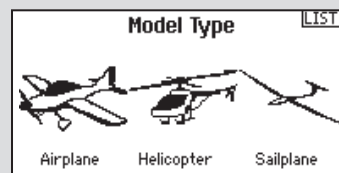

Model Name

Model Name enables you to assign a custom name to the current model memory. Model names can include up to 20 characters including spaces.

To add letters to a Model Name:

1. Scroll to the desired letter position and press the scroll wheel once. A flashing box appears.
2. Scroll left or right until the desired character appears. Press the scroll wheel once to save the character.
3. Scroll to the next desired letter position. Repeat Steps 1 and 2 until the Model Name is complete.
4. Select BACK to return to the System Setup list.

To erase a character:

1. Press CLEAR while the character is selected.
2. Press CLEAR a second time to erase all characters to the right of the cursor.

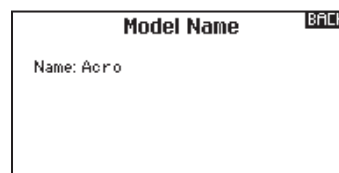

F-Mode Setup

Use the Flight Mode Setup menu to assign switches to flight modes.

Mode	Number of Switches	Number of Flight Modes
Aircraft	2	5
Heli	3 (including Throttle Hold)	5 (including Throttle Hold)



Sailplane Flight Mode Setup

You can assign up to ten flight modes using any combination of up to three switches. You can also assign a priority switch. When the priority switch position is active, only the current flight mode is active, regardless of other switch positions.

Aircraft and Sailplane Flight Mode Table

You can assign the available flight modes (up to 5 for Air, up to 10 for Sail) to each of the switch positions (up to 3 switches can be used for sailplane and up to 2 switches can be used for aircraft). Press NEXT from the Flight Mode Name page to access the flight mode table assignment page when Custom flight mode has been selected in the Flight Mode Setup page. The combination of up to 2 or 3 switches can be used to access all of the flight modes available.

Number of Flight Modes	2	3	3*	4	4	5
Switch 1 (number of positions)	2P	3P	2P	2P	3P	3P
Switch 2 (number of positions)			2P	3P	2P	3P
Flight Mode	Launch	Launch	Launch	Launch	Launch	Launch
1						
2	Cruise	Cruise	Cruise	Cruise	Cruise	Cruise
3		Land			Land	Land
4			Thermal	Thermal	Thermal	Thermal
5				Speed		Speed

*Must be set up in a 4/5 flight mode.

Spoken Flight Mode Setup

Enables you to assign custom names to the Flight Mode positions. Flight Mode names can include up to 20 characters including spaces.

To change the Flight Mode name:

1. Scroll to the Flight Mode name you wish to change and press the scroll wheel.
2. Scroll to the character position you wish to change and press the scroll wheel once. A flashing box appears.
3. Scroll left or right until the desired character appears. Press the scroll wheel once to save the character.
4. Repeat Steps 2 and 3 until the Model Name is complete.
5. Select BACK to return to the Flight Mode Names list.

Spoken Flight Mode:

The Spoken Flight Mode option enables you to activate audio flight mode alerts. As you change between flight modes, the transmitter will "speak", informing you of the active flight mode. You can select a word or phrase for each flight mode.

To activate Spoken Flight Mode:

1. Enter the Spoken Flight Mode menu option.
2. Scroll to <Silence> (default), then press the scroll wheel.
3. Scroll left or right to view the options.
4. Press the scroll wheel again to save the selection.

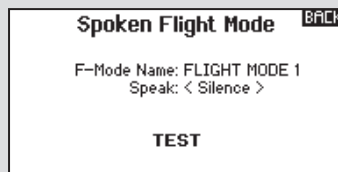
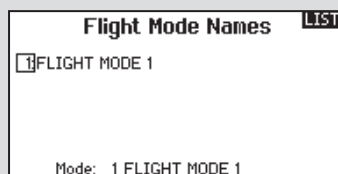

Channel Assignment

The Channel Assignment function allows you to reassign almost any receiver channel to a different transmitter channel. For example, the receiver gear channel could be re-assigned to the transmitter throttle channel.

1. Scroll to the receiver channel you wish to change.
2. Press the scroll wheel once and scroll left or right to change the receiver input selection.
3. Press the scroll wheel a second time to save the selection.

IMPORTANT: You cannot assign a mix to a channel that has been moved. Create the mix first, then move the channel.

Rx Port Assignments		LIST
1 THRO: Throttle	6 AUX1: Aux 1	
2 AILE: Aileron	7 AUX2: Aux 2	
3 ELEV: Elevator	8 AUX3: Aux 3	
4 RUDD: Rudder	9 AUX4: Aux 4	
5 GEAR: Gear		

NEXT

Channel Input Configuration

The Channel Input Configuration screen enables you to assign a transmitter channel to a different control stick or switch.

1. Select **NEXT** on the RX Port Assignments screen to access the Channel Input Configuration screen.
2. Scroll to the transmitter channel you wish to re-assign and press the scroll wheel. The box around the current input selection flashes.
3. Scroll left or right to select the desired control stick or switch.
4. Press the scroll wheel to save the selection.

Channel Input Config		LIST
1 THRO: N/A	6 AUX1: D	
2 AILE: N/A	7 AUX2: E	
3 ELEV: N/A	8 AUX3: RKnB	
4 RUDD: N/A	9 AUX4: LLv	
5 GEAR: A		

PREV

Trim Setup

Use the Trim Setup screen to change the size of the trim step and the trim type.

Trim Step

Adjusting the trim step value determines how many “clicks” of trim you input each time you press the trim button. Changing the trim step value to 0 disables the trim for the channel.

To change the trim step value:

1. Scroll to the trim step channel you wish to change.
2. Select the trim step value and scroll left or right to change the value.
3. Press the scroll wheel to save the selection.

Trim Type

The two Trim Type options are *Common* and *F Mode*.

Common trim type maintains the same trim values for all flight modes.

F Mode trim type enables you to save trim values for individual flight modes if you find, for example, the aircraft requires aileron trim in Flight Mode 1 but not in Flight Mode 2.

Trim Assignment

In a few instances, you can reassign a trim to a different location.

Aircraft Model Type

Throttle

- Throttle Digital trim button (default)
- Left Analog lever
- Right Analog lever

Throttle Trim Type

- Common
- Flight Mode

Trim Setup		LIST
	Trim Type	
Throttle:	5 Common Digital	
Aileron:	5 Common	
Elevator:	5 Common	
Rudder:	5 Common	
Left Trimmer:	5 Common	
Right Trimmer:	5 Common	
Trims: Normal		

Helicopter Model Type

Throttle and Pitch Hover Trim—Used to trim the throttle and pitch setting for precision hovering. This does not affect normal throttle trim operation.

- Right Knob
- Left Analog Lever
- Right Analog Lever
- L Trim
- R Trim

Active Gyro and Governor Trim—Used to trim the gyro and governor settings in flight.

- L Trim
- R Trim

Trim Location

Normal and Cross trim types are available. Normal trims align with the control stick; for example, the throttle trim is next to the throttle stick.

Cross trims reverse the position of the trims; for example, the throttle trim is next to the elevator stick and vice versa.

To change the Trim Position from Normal to Crossed, select Normal at the bottom of the Trim Setup screen and press the scroll wheel.

IMPORTANT: Crossed trims will cross both sets of trims for both gimbals.

MODEL UTILITIES

In the Model Utilities function you can create a new model, delete a model, copy a model, reset a model to default settings and sort the model list.

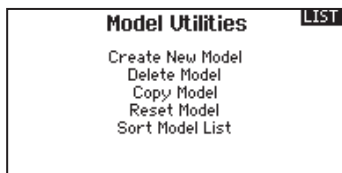

Create New Model

Use this selection to create a new model in the model select list.

1. Select Create New Model. Within this screen, you will have the option to create a new model or cancel.
2. If you select Cancel, the system will return to the Model Select function.
3. If you select Create, the new model will be created and now be available in the model select list.

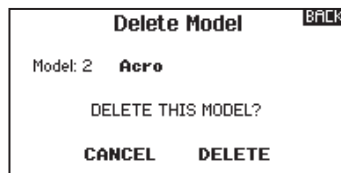

Delete Model

Use this selection to permanently delete a model from the model select list. If you do not wish to delete a model, select Cancel to exit the page.

1. To delete a model, highlight the model listed. Press to select then roll to the model name. Press the roller to select.
2. Select DELETE to delete the model.

Copy Model

The Model Copy menu enables you to duplicate model programming from one Model List location to another.

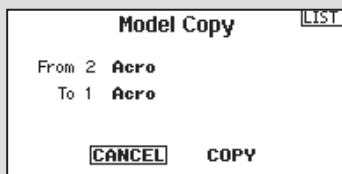

Use Model Copy to:

- Save a default model copy before experimenting with programming values
- Expedite programming for a model using a similar programming setup

IMPORTANT: Copying a model program from one model memory to another will erase any programming in the “To” model memory.

To copy model programming:

1. Make sure the model program you wish to copy is active. If the desired model program is not active, select Cancel and change the active model in the Model Select menu.
2. Select the model memory next to “To” and scroll to the desired model memory. Press the scroll wheel once to save the selection.
3. Select Copy and the Confirm Copy screen appears.
4. Select Copy to confirm. Selecting Cancel will return to the System Setup screen.
5. Select the “To” model as the current model, then bind the transmitter and receiver. Copying a model does not copy the bind from the original model.

You cannot use the Model Copy screen to copy model programming to an SD Card. To copy model programming to the SD Card, please see “Transfer SD Card”.

Model Reset

Use the Model Reset menu to delete all model programming in the active model memory. Reset returns all model settings to the default settings and erases all programming in the selected model.

After a model reset, it is necessary to re-bind.

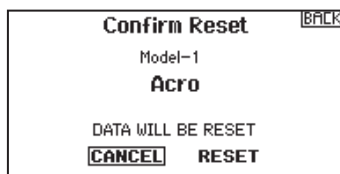

Sort Model List

With this function you can sort the model order in the model select function. This is helpful to group similar models together to make them easy to find. To move a model, highlight the model that you wish to move with the roller, then press the roller to highlight it. Then roll with the roller to move the selected model to the position desired. Press the roller when you have the model in the position desired.

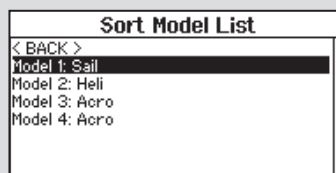

Warnings

The Warnings menu enables you to program a tone or vibration alert during power on of the transmitter for any selected switch or channel position.

The alarm activates and an alert message appears on the screen if a specific switch or control stick is in an unsafe position when you power the transmitter on.

Return the switch or control stick to the safe position to silence the alarm.

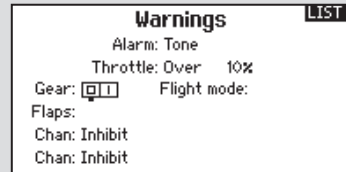

For safety reasons, the default throttle alarm activates if the throttle position is above 10%.

Telemetry

Installing the optional telemetry module and sensors enables the display of aircraft performance data on the transmitter screen. You can also enable Data Logging to save a telemetry file on the SD Card and view the data in the Spektrum STI™ mobile application.

Telemetry Settings

Display

Telemetry display options include:

Tele: When you press the scroll wheel, the Telemetry screens appear and the Main Screen is disabled.

Main: Telemetry alerts appear on the Main screen, but all Telemetry screens are disabled.

Roller (Default): Allows you to toggle between the Telemetry screens and the main screen by pressing the scroll wheel.

Auto: The Telemetry screen automatically appears as soon as the transmitter receives data from the telemetry module.

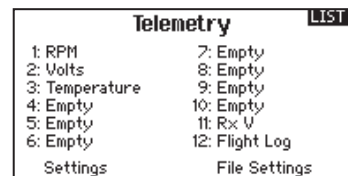

Units

Scroll to Units and press the scroll wheel to change between US and Metric.

Telemetry Auto-Configuration

IMPORTANT: The Auto-Config option is not available from the System Setup>Telemetry menu. RF signal must be transmitting when you use the Auto-Config option. When the System Setup menu is active, RF signal is off.

The DX9 transmitter features telemetry Auto-Configuration, allowing the transmitter to detect new telemetry sensors.

To use Telemetry Auto-Config:

1. Make sure all telemetry components are bound to the transmitter and receiver.
2. Power on the transmitter, then power on the receiver.
3. Select Telemetry from the Function List, then select Auto Config. "Configuring" flashes for 5 seconds and any new sensors appear in the list.
4. Adjust the sensor alert values as necessary.

Status Reports:

Status Reports determines how often the transmitter refreshes the data on the screen. Each telemetry sensor can be adjusted independently.

For example, the RPM status report can refresh every 10 seconds while the altimeter sensor refreshes every 15 seconds.

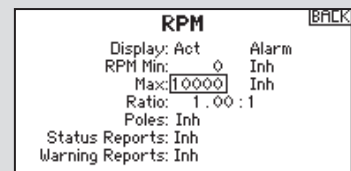

Warning Reports:

Warning Reports determines how often a telemetry alert occurs, if an alert is active.

Telemetry Alarms

Select Inh under Alarm to select the type of alarm desired. Options include **Inh**, **Tone**, **Vibe**, **Tone/Vibe**, **Voice**, **Voice/Vibe**.

Status Reports (Spoken Telemetry)

1. Select Inh next to Status Reports in each telemetry setting to add spoken telemetry feedback as desired.
2. Scroll to select how often you want to hear the status report.

Warning Reports (Spoken Telemetry)

1. Select Inh next to Warning Reports in each telemetry setting to add spoken telemetry feedback for telemetry warnings as desired.
2. Scroll to select how often you want to hear the telemetry warning.

File Settings

This is used to select the data logging settings.

File Name

1. Select File Name to assign a custom file name.
2. The File Name screen appears, allowing you to name the file as you would for a Model Name or Flight Mode Name. The file name can include a maximum of 8 characters.
3. Press BACK to save the name.

Start

1. Select Start to assign a specific switch position or stick position that activates Data Logging.
2. Press the scroll wheel once to save the selection.

Enabled

When Enabled is set to NO, Data Logging is turned off. Select YES to save Telemetry data to the SD Card. The SD Card must be installed in the transmitter to select YES.



CAUTION: If you access the Telemetry menu from the Function List, you may see a Frame Loss appear when you exit the menu. The Frame Loss is not an error, but there will be a momentary loss of radio signal when exiting the Telemetry screen. **DO NOT** access the Telemetry menu during flight.

Preflight Setup

The Preflight Setup menu option enables you to program a pre-flight checklist that appears each time you power on the transmitter or when you select a new model memory. Each item on the list must be confirmed before you can access the Main Screen.

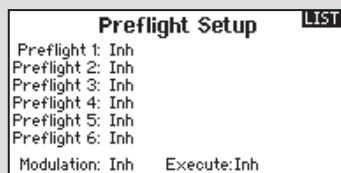

Frame Rate

The Frame Rate menu enables you to change the frame rate and modulation mode. Select the option you wish to change and press the scroll wheel.

You must use digital servos if you select 11 ms frame rate. Analog and digital servos can be used with a 22ms frame rate.

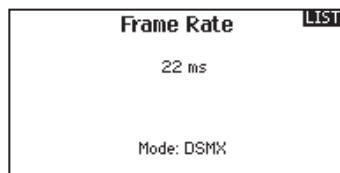

Modulation Mode

We recommend using DSMX (default) modulation mode. When DSMX is active, the transmitter operates in DSMX with DSMX receivers and DSM2 with DSM2 receivers. The transmitter automatically detects DSM2 or DSMX during binding and changes the mode accordingly to match the receiver type you are using. If you select DSM2, the transmitter operates in DSM2 regardless of whether it is bound to a DSM2 or DSMX receiver.

NOTICE: While DSMX allows you to use more than 40 transmitters simultaneously, do not use more than 40 transmitters simultaneously when using a DSM2 receiver or a transmitter in DSM2 mode.

Bind

The Bind menu enables you to bind a transmitter and receiver without powering off the transmitter. This menu is helpful if you are programming a model and need to bind the receiver for failsafe positions.

See “Programming Failsafe Positions” for more information.

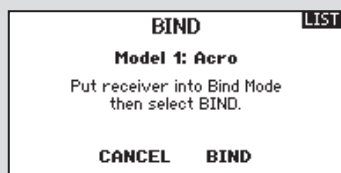

TRAINER

The DX9 features a programmable trainer function with 4 wired trainer modes and 2 wireless trainer modes. The transmitter assigns the trainer function to Switch I.



Wired Trainer

The 4 wired trainer modes include:

Inhibit

In Inhibit, the slave transmitter must have the same programming as the master transmitter (e.g., servo reversing, travel adjust, sub-trim, trims).

Programmable Master

Programmable mode enables you to program the master transmitter to transfer any or all individual channels when you activate the trainer switch. This mode is ideal for beginners learning to control individual channels while the master transmitter maintains control of all other channels.

The slave transmitter should be in Inhibit mode, if available.

The Master and Slave transmitters MUST have the same programming.

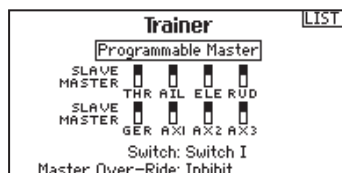

Pilot Link Master

Pilot Link Master enables you to program the master transmitter to transfer any or all individual channels when you activate the trainer switch. Pilot Link Master is ideal for complex models, as the master transmitter can maintain control of all secondary functions—for example flight modes, retracts, flaps and brakes. Secondary functions can be individually assigned to the Slave transmitter as necessary. It is not necessary to have model programming in the slave transmitter.

It may be necessary for the slave transmitter to be in Inhibit mode to allow trim changes to transfer over from the master transmitter.

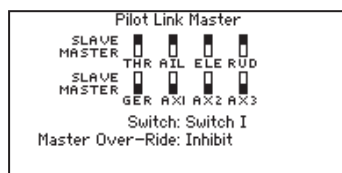

Slave

Use Slave mode when using the DX9 as a slave transmitter and Pilot Link is active in the master transmitter.

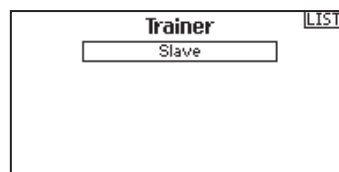

DX9 Wired Trainer Operation

1. Bind the master transmitter to the model.
2. Connect the trainer cord (SPM6805) to the back of the master transmitter.
3. Make sure the master and slave transmitter battery packs are fully charged.
4. Make sure the slave transmitter is powered off. The slave transmitter receives power when you connect the trainer cord.
5. Connect the trainer cord to the slave transmitter.
6. The slave transmitter screen displays information but does not send a signal to the model.
7. Press the trainer button on the master transmitter to transfer model control from the master to the slave.
8. While moving the trainer switch between the off and on positions, watch for movement on the control surfaces. Adjust the trims as necessary before flying.
9. Release the trainer button and the master transmitter regains control of the model.

Master Override

The Master Override feature enables the instructor to immediately regain control of the model by moving the control sticks. After you activate Master Override, the slave transmitter cannot control the model until you reset the trainer switch. To reset the trainer switch:

1. Move the trainer switch to the OFF position.
2. Move the trainer switch to the ON position to activate the slave transmitter.

Wireless Trainer

Wireless Trainer works just like the Wired Trainer, without the wire. Select Wireless Trainer to bind a DSM2 or DSMX slave transmitter to the master transmitter. With this option, when the master presses the trainer button or switch, control is given to the currently bound slave transmitter. After binding, the slave transmitter will remain bound to the master transmitter until a different transmitter is bound to the master, or the slave transmitter is bound to another receiver or a wireless master transmitter. ModelMatch™ technology applies to the wireless trainer system; the master transmitter will be bound to the slave in the bound model used. Also if the slave transmitter has ModelMatch technology, it will only be bound to the master transmitter in the selected model during binding.

Inhibit

In Inhibit, the wireless trainer function will be inhibited and will not function.

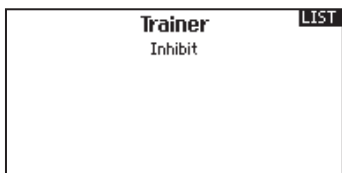

CAUTION: Select Inhibit in the Trainer menu when you aren't using the wireless trainer function. Failure to select Inhibit may result in loss of control of the aircraft.

Programmable Master

Programmable mode enables you to program the master transmitter to transfer any or all individual channels when you activate the trainer switch. This mode is ideal for beginners learning to control individual channels while the master transmitter maintains control of all other channels. The slave transmitter should be in Inhibit mode, if available. The Master and Slave transmitters **MUST** have the same programming.

Pilot Link Master

Pilot Link Master enables you to program the master transmitter to transfer any or all individual channels when you activate the trainer switch. Pilot Link Master is ideal for complex models, as the master transmitter maintains control of all secondary functions, such as flight modes, retracts, flaps and brakes. Secondary functions can be individually assigned to the Slave transmitter as necessary. It is not necessary to have model programming in the slave transmitter.

DX9 Wireless Trainer Operation

1. Enter an unused model on the slave transmitter (computer transmitter only).
2. Bind the master transmitter to the model.
3. Make sure the master and slave transmitter battery packs are fully charged.
4. Make sure the slave transmitter is powered off.
5. Either in the Wireless Programmable Master setup page or the Wireless Pilot Link Master setup page, select BIND. This will put the master transmitter's wireless trainer receiver into bind mode. You should see the following screen:



6. Enter bind mode on the slave transmitter following the instructions provided with that transmitter.
7. After a successful bind, the following screen should appear.



8. Press the trainer button on the master transmitter to transfer model control from the master to the slave.
9. Release the trainer button and the master transmitter regains control of the model.

Master Override

The Master Override feature enables the instructor to immediately regain control of the model by moving the control sticks. After you activate Master Override, the slave transmitter cannot control the model until you reset the trainer switch. To reset the trainer switch:

1. Move the trainer switch to the OFF position.
2. Move the trainer switch to the ON position to activate the slave transmitter.

SYSTEM SETTINGS

The System Settings menu consists of four screens: System Settings, Extra Settings, Serial Number and Calibrate. Select **NEXT** or **PREV** to move between screens.

User Name

The User Name field displays your name in the lower right corner of the main screen.

To Program a User Name:

1. Scroll to User Name and press the scroll wheel. The User Name screen appears.
2. Scroll to the desired character position and press the scroll wheel. Scroll left or right to change the character and press the scroll wheel to save the selection. The User Name can contain a maximum of 20 characters, including spaces.

3. Press the Back button to save the User Name and return to the System Settings screen.

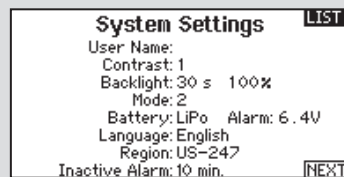

Contrast

To adjust the screen contrast:

1. Scroll to Contrast and press the scroll wheel.
2. Scroll left or right to adjust the contrast value. Lower numbers lighten the contrast, higher numbers darken it.
3. Press the scroll wheel once to save the selection.

Backlight

The Backlight field adjusts the backlight appearance time and brightness. You have the option to turn the backlight off for models you fly during the day and turn the backlight on for night flying models.

The backlight time options are:

- Off:** Appears for a short time when you power on the transmitter.
- On:** The backlight is always on.

Set Time: The backlight is on for 3, 10, 20, 30, 45 or 60 seconds before automatically turning off. Press the scroll wheel once to turn the backlight on.

The backlight percentage adjusts the backlight intensity and it is adjustable in 10% increments from 10% (darker) to 100% (brighter).

Mode

You can change transmitter modes among Modes 1, 2, 3 and 4. This conversion requires both a programming and a mechanical change. Please refer to Transmitter Mode Conversion for directions on making the necessary mechanical changes. If mechanical changes are required for the mode you need to change to, complete the mechanical changes first, then follow the instructions below for the software setting change.

To change the gimbal stick mode:

1. Scroll to Mode and press the scroll wheel.
2. Scroll left or right to change the gimbal stick mode. Press the scroll wheel to save the selection.
3. Select **NEXT** in the lower left corner until the Calibration screen appears.
4. Move all transmitter controls to the center position and complete the calibration process before exiting the System Settings menu. See "Calibrating Your Transmitter" for more information.

Battery Alarm

Battery Alarm enables you to change the transmitter battery type and the alarm voltage limit. The alarm activates when the battery reaches the low voltage limit.

To change the battery alarm:

1. Scroll to the battery type and press the scroll wheel once to change the type to LiPo/Li-Ion or NiMH.
2. Scroll to the battery voltage and press the scroll wheel. Turn the scroll wheel left or right to change the voltage level. Press the scroll wheel again to save the selection.

CAUTION: Never select NiMH when a LiPo/Li-Ion battery is installed in the transmitter. Doing so may over-discharge the LiPo battery and damage the battery, transmitter or both.

CAUTION: Never adjust the low voltage limit for the LiPo/Li-Ion battery pack below 6.4V. Doing so could over-discharge the battery pack and damage both battery pack and transmitter.

Selecting a Language

In the Systems Settings screen, rotate the roller to highlight Language, then press the roller to select the Language function. Rotate the roller to select the desired Language. When the desired Language is selected, press the roller to accept that Language. Names you input will not be affected by language change. After changing the language for the text, you may also want to change the language for the spoken alerts. See the “Spoken” and “SD Card” sections for more information.

Inactive Alarm

An alarm activates if the transmitter sees a period of inactivity for a certain amount of time. The alarm is helpful in reminding you to power off the transmitter and avoiding a situation where the transmitter battery completely discharges.

The Inactive Alarm options are:

- Inh (No alarm sounds)
- 5 min
- 10 min (Default)
- 30 min
- 60 min

To change the Inactive alarm time:

1. Scroll to the current alarm time and press the scroll wheel.
2. Scroll left or right to change the alarm time. Press the scroll wheel to save the selection.

Extra Settings

The Extra Settings screen enables you to:

- Turn sounds off or on
- Turn vibration off or on
- Change the appearance of the trim indicators.

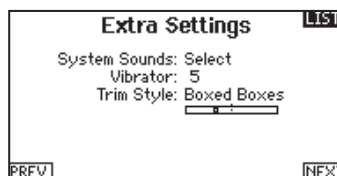

System Sounds

Scrolling to System Sounds and pressing the scroll wheel turns sounds on (Active) or off (Inhibit).

You may disable all sounds by changing the volume to 0.

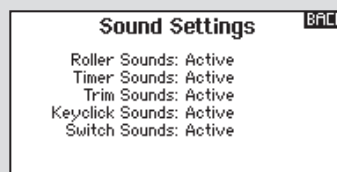

Vibrator

Scrolling to Vibrator and pressing the scroll wheel turns vibration alerts on (Active) or off (Inhibit).

Trim Display

Trim display changes the shape of the trim indicators on the Main Screen. Display options include:

- Boxed Boxes (Default)— The indicators appear as an outlined box when you adjust the trim.
- Boxed Arrows— The indicators appear as outlined arrows when you adjust the trim.
- INH— The indicators appear as arrows on lines when you adjust the trim.

Inhibit removes all trim bars and indicators from the Main Screen.

To change the Trim Display:

1. Scroll to Trim Display and press the scroll wheel once.
2. Scroll left or right to change the Trim Display option. Press the scroll wheel to save the selection.

Serial Number

The Serial Number screen displays the transmitter serial number and AirWare software version.

Reference the Serial Number screen any time you need to register your transmitter or update the AirWare software from the Spektrum Community website.

Exporting the Serial Number to the SD Card

You may find it helpful to export the transmitter serial number to a text file for your personal records or when you are registering the transmitter on the Spektrum Community.

To export the transmitter serial number:

1. Insert an SD Card in the card slot on the transmitter.
2. Scroll to **EXPORT** and press the scroll wheel. The SD Status screen appears and should display MY_DX9.xml in the middle of the screen.
3. Press the scroll wheel again to return to the Serial Number screen.
4. Power off the transmitter and remove the SD Card from the transmitter.
5. Install the SD Card in a card reader connected to your computer.
6. Open the MY_DX9.xml file from the SD Card location. You can then copy and paste the serial number into your personal records or to the Spektrum Community website.

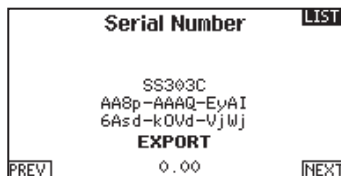

Locating the Transmitter AirWare Software Version

The transmitter AirWare software version appears between **PREV** and **NEXT** at the bottom of the Serial Number screen. Register your DX9 to get AirWare software updates and other news at spektrumrc.com

IMPORTANT: AirWare files are specific to the transmitter serial number and you cannot transfer AirWare files between transmitters, i.e., downloading an AirWare software update once and attempting to install it on multiple transmitters.

Calibrate

The Calibration screen stores the potentiometer endpoints for all proportional controls. It is mandatory to complete the calibration after changing the stick mode selection.

Calibrating the Transmitter

1. Carefully move the gimbal sticks in a + shape moving from left to right, then up and down. Press gently on the gimbals at the stops to achieve an accurate calibration. Return both gimbal sticks to the center position.
2. Move the Left and Right Side Levers to the top and bottom positions, then move the side levers to the center position.

IMPORTANT: Only move one side lever at a time during calibration.

3. Move the Knob to the full clockwise and counterclockwise positions, then return the Knob to the center position.
4. Select **SAVE** to store the calibration.

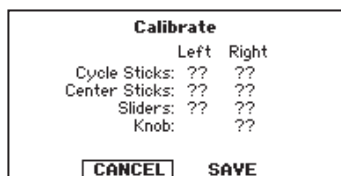

TRANSFER SD CARD

Import Model

This function overwrites all model memories. Ensure that the models currently in your transmitter are saved on an SD card separate from the transmitter before performing this function.

To import an individual model file from the SD Card:

1. Save the model file to the SD Card.
2. Select the Model List location where you wish to import the new model file.
3. In the SD Card menu, scroll to Select Option and press the scroll button once.
4. Scroll to Import Model and press the scroll button again to save the selection. The Select File screen appears.
5. Select the model file you wish to import. The Overwrite screen appears.

IMPORTANT: When you select Import, the transmitter leaves the System Setup List.

6. Select the model that you would like to import the model to.
7. Select Import to confirm overwriting the current model file. The transmitter activates the new model file and the Main Screen appears.

A Preflight Checklist may appear prior to the Main Screen if the

checklist was active during the model file export. Select MAIN to exit the Preflight Checklist.

See “Preflight Setup” for more information.

Import All Models

To import all models from the SD Card:

1. Select Import All Models
2. Confirm by selecting **IMPORT**.

IMPORTANT: After importing a model, you must rebind the transmitter and receiver. The Main Screen must show DSM2 or DSMX in the upper left corner.

You can import a model to any location you want. If you prefer to use Import All, you can use your PC to rename the SPM file. The first two digits (01 to 50) are the destination model number. Your SD card can only contain 50 models. Save files to folders on the card then remove from the card all unused models. Files are selected by their position in the directory table.



Export Model

You can use the Export Model option to export a single model file to the SD Card.

1. Make sure the active model file is the one you wish to Export.
2. Scroll to Select Option and press the scroll button once.
3. Scroll to Export Model and press the scroll button again to save the selection. The Export to SD screen appears. The first two characters of the file name correspond to the Model List number (01, for example).
4. (Optional) If you wish to rename the model file before exporting it to the SD Card:
 - a. Scroll to “Save to:” and press the scroll wheel. The File Name screen appears.
 - b. Assign a new file name. The file name can contain up to 25 characters including the .SPM file extension.
 - c. When you are done assigning the new file name, press the Back button to return to the Export to SD screen.
5. Select Export to save the file to the SD Card. When the export is complete, the transmitter returns to the SD Card Menu screen.

Export All Models

To export all models to the SD Card:

1. Select Export All Models in the SD Card Menu options. The Export All Models screen appears.

IMPORTANT: Export All Models will overwrite any model files that:

- Are already saved on the SD Card.
 - Have the same name. Always save model files to a different SD Card if you are not sure.
2. Select Export to overwrite files on the SD Card or Cancel to return to the SD Card Menu.

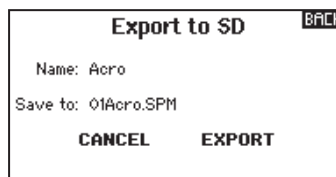

Updating Spektrum DX9 Sound Files

NOTICE: NEVER disconnect the battery from the transmitter while the file transfer is in process. Doing so will damage the transmitter, and the transmitter will need to be returned for service.

You have the option of installing new sound files in the DX9 transmitter. Before updating the sound files, make sure the transmitter battery is fully charged.

To install new sound files:

1. Download the desired sound file from the Spektrum Community at www.SpektrumRC.com. Save the file to the SD card for your transmitter.

2. Insert the SD card in the DX9 transmitter.
3. Enter System Setup in the transmitter.
4. Select the SD Card menu, and then select Update Sound.
5. Select the new sound file you want to install. The transmitter will scan the file and check for any errors.
6. The Transfer SD Card screen reappears when the file transfer is complete.

IMPORTANT: The sound file will take approximately 1 hour to update. Do not disconnect the battery or power off the transmitter during the update.

Update AirWare Software

IMPORTANT: The orange LED Spektrum bars flash and a status bar appears on the screen when AirWare software updates are installing. Never power off the transmitter when updates are installing. Doing so may damage the system files.

Before installing any AirWare files, always Export All Models to an SD Card separate from the SD Card containing the update. The update may erase all model files.

For more information on AirWare software updates, visit spektrumrc.com

Automatically Installing AirWare Software Updates

To install the most recent update:

1. Download the update from spektrumrc.com and save it to the SD Card.

2. Power off the transmitter and install the SD Card in the transmitter.
3. Power on the transmitter and the update automatically installs in the transmitter.

Manually Installing AirWare Software Updates

1. Save the desired AirWare version to the SD Card.
2. Select Update Firmware in the SD Card Menu options. The Select File screen appears.
3. Select the desired AirWare version from the File List. When updates are installing, the transmitter screen is dark. The orange LED Spektrum bars flash and the update status bar appears on the screen.

NOTICE: Do not power off the transmitter when updates are installing. Doing so will damage the transmitter.

FUNCTION LIST

Servo Setup

The Servo Setup menu contains the following functions:

- Travel Adjust
- Sub-Trim
- Reverse
- Speed
- Abs. (Absolute) Travel
- Balance

Travel Adjust

Travel Adjust sets the overall travel or endpoints of the servo arm movement.

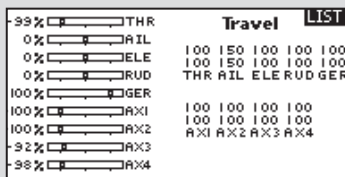

To adjust travel values:

1. Scroll to the channel you wish to adjust and press the scroll wheel. When adjusting travel values assigned to a control stick:
 - a. Center the control stick to adjust both directions at the same time.
 - b. To adjust travel in one direction only, move the control stick in the direction you wish to adjust. Continue holding the control stick in the desired direction while you are adjusting the travel value.
2. Scroll left or right to adjust the travel value. Press the scroll wheel to save the selection.

Sub-Trim

Sub-Trim adjusts the servo travel center point.

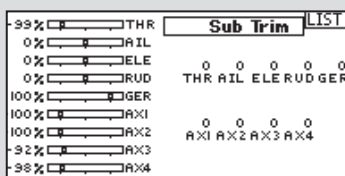

CAUTION Use only small sub-trim values or you may cause damage to the servo.

Reverse

Use the Reverse menu to reverse the channel direction. For example, if the elevator servo moves up and it should move down.

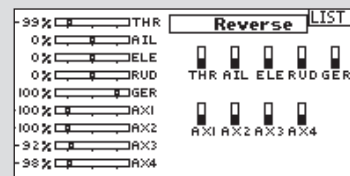

To reverse a channel direction:

1. Scroll to Travel and press the scroll wheel. Scroll left until Reverse appears and press the scroll wheel again to save the selection.
2. Scroll to the channel you wish to reverse and press the scroll wheel.

If you reverse the Throttle channel, a confirmation screen appears. Select YES to reverse the channel. A second screen appears, reminding you to bind your transmitter and receiver.



CAUTION: Always rebind the transmitter and receiver after reversing the Throttle channel. Failure to do so will result in the throttle moving to full throttle if failsafe activates.

Always perform a control test after making adjustments to confirm the model responds properly.



CAUTION: After adjusting servos, always rebind the transmitter and receiver to set the failsafe position.

Speed

The Speed menu enables you to show the response time on any individual channel (such as retracts).

The Speed is adjustable in the following ranges:

- Nor (No Delay) — 0.9s in 0.1 second increments
- 1s – 2s in 0.2-second increments
- 2s – 8s in 1-second increments

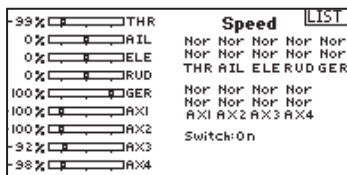

To adjust the Speed:

1. Scroll to the channel you wish to adjust and press the scroll wheel.
2. Scroll left or right to adjust the speed and press the scroll wheel to save the selection.

D/R & Exponential

Dual Rates and Exponential are available on the aileron, elevator and rudder channels.

To adjust the Dual Rate and Exponential:

1. Scroll to the channel and press the scroll wheel once. Scroll left or right to select the channel you wish to change and press the scroll wheel again to save the selection.
2. Scroll to dual rate and press the scroll wheel. Scroll left or right to change the value and press the scroll wheel again to save the selection.

Exponential affects control response sensitivity around center but has no affect on overall travel. Positive exponential decreases the sensitivity around the center of gimbal movement.

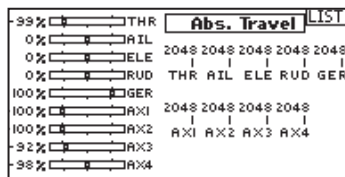

Absolute (Abs.) Travel

The Abs. Travel function limits the amount of travel on a channel. Adjust the Abs. Travel value to prevent a servo from binding when a mix is applied.

Balance

Balance is available on all channels to fine-tune the servo position at up to 7 points. This is a precision curve mix that is normally used to prevent binding when multiple servos are used on a single control surface.

You can also use the Balance menu option to match throttle response on twin engine aircraft or level the swashplate on a helicopter.

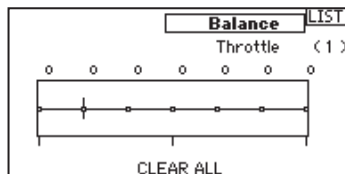

Differential (Air and Sail Types only)

The Differential screen enables you to increase or decrease the amount of differential between aileron control surface throws.

Positive Differential values decrease the amount of “down” travel without affecting the “up” travel on the opposite control surface.

Negative Differential values decrease the amount of “up” travel without affecting the amount of “down” travel on the opposite control surface.

The Differential menu option only appears when a multi-servo aileron wing type is active in Aircraft Type.

To adjust the Differential:

1. Scroll to Switch and press the scroll wheel. Scroll right to select On (Differential is always on) or assign the differential to a switch position.
2. Press the scroll wheel a second time to save the selection.

3. Scroll to the percentage selection and press the scroll wheel once to change the value.
4. Press the scroll wheel again to save the selection.

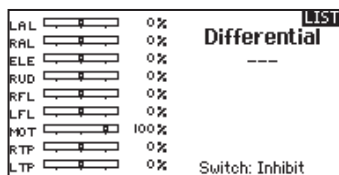

V-Tail Differential (Air and Sail Types only)

The V-Tail Differential screen enables you to increase or decrease the amount of differential between control surface throws.

Positive Differential values decrease the amount of “down” travel without affecting the “up” travel on the opposite control surface.

Negative Differential values decrease the amount of “up” travel without affecting the amount of “down” travel on the opposite control surface.

The V-Tail Differential menu option only appears when V-Tail A or V-Tail B is active in Aircraft Type.

To adjust the V-Tail Differential:

1. Scroll to Switch and press the scroll wheel. Scroll right to select On (Differential is always on) or assign the differential to a switch position.

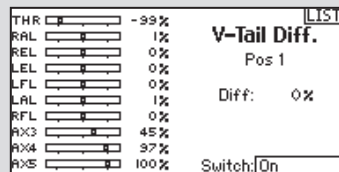

2. Press the scroll wheel a second time to save the selection.
3. Scroll to Diff: and press the scroll wheel once to change the value.
4. Press the scroll wheel again to save the selection.

Throttle Cut

The Throttle Cut menu option enables you to assign a switch position to stop an engine or motor. Throttle Cut activates regardless of Flight Mode.

When you activate Throttle Cut, the throttle channel moves to the pre-programmed position (normally Off).

You may need to use a negative value to move the Throttle channel to the off position.

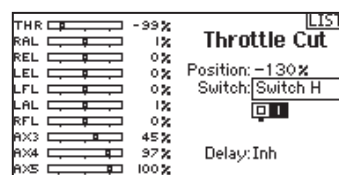

CAUTION: Always test the model after making adjustments to make sure the model responds to controls as desired.

Throttle Curve

You can use the Throttle Curve menu option to optimize the throttle response. A maximum of 7 points are available on the throttle curve.

To add points to a Throttle Curve:

1. Move the throttle stick to the position where you wish to add the new point.
2. Scroll to Add Pt. and press the scroll wheel to add the point.

To remove points from a Throttle Curve:

1. Move the Throttle stick until the cursor is near the point you wish to remove.
2. Scroll to Remove Pt. and press the scroll wheel once to remove the point.

If you program multiple throttle curves and you wish to edit one of the curves, that curve must be active in the Throttle Curve screen before you can make any changes.

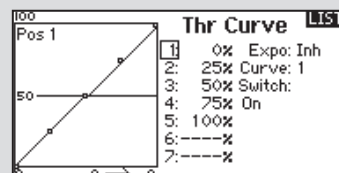

Mixing

Mixing allows control input for a channel to affect more than one channel at a time. Mixing functions support:

- Mixing a channel to another channel.
- Mixing a channel to itself.
- Assigning offset to a channel
- Linking primary to secondary trim.

These mixes are available for each model memory:

- 10 programmable mixes
- Rudder to Aileron/Elevator (ACRO).
- Cyclic to Throttle (HELI)
- Aileron>Rudder (SAIL)
- Swashplate (HELI)
- Aileron>Flap (SAIL)
- Elevator to Flap (ACRO)
- Elevator>Flap (SAIL)
- Aileron to Rudder (ACRO)
- Flap>Elevator (SAIL)

Select a channel for master and slave. Inputs for the master channel control both the master and slave channels. For example, Elevator to Flap makes elevator the master channel and flap the slave channel.

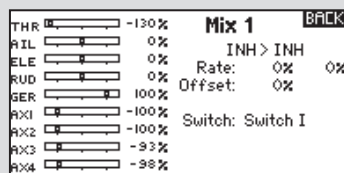

Offset

Change the offset value to move the effective center position of the slave channel. Positive or negative value determines the direction of the offset. Offset is not available for curve mixes.

Trim

If the master channel trim should also adjust the slave channel, set Trim to Act. A channel monitor on the left side of the screen

shows how channels respond to input. To view a switch-assigned mix on the monitor, the mix switch must be in the active position.

Assigning a Mix to a Switch

If you wish to assign a mix to a switch position:

1. Make sure you are in the desired mix screen.
2. Move the switch you want to assign the mix to.
3. Scroll to the switch position where you want the mix to be active.
4. Press the scroll wheel to activate the mix. When the box is filled, the mix is active.

The mix is Active when the box is filled and Inactive when the box is open. You can assign a mix to be active in multiple switch positions (0,1 or 2).

Tip: Use Auto Switch Select to select the switch.



CAUTION: Always do a Control Test of your model after changing mixes.

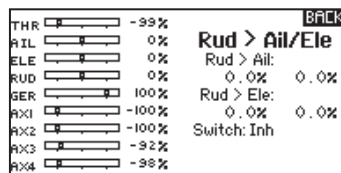

Back Mixing

Back Mixing applies a mix to all related servos in a wing or tail type. For example, if you select 2 AIL, 2 FLAP in the Aircraft Type screen, a mix to one aileron channel affects both aileron servos. The mix response, however, depends on the aileron channel included in the mix.

A Back Mix also enables you to use fewer mixes to achieve the desired response, for example adding roll to a split elevator.

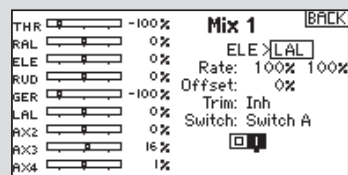

Sequencer

The Sequencer menu option provides this-then-that mixing with a time delay. Two different sequences (S1 through S2) are available to control 2 functions each (A and B), in 2 timing directions (forward or reverse). Sequences appear throughout function screens as assignable switches.



CAUTION: Always review the action of a sequence on the Monitor screen BEFORE operating the model to ensure controls act as desired. Failure to do so could cause a crash, resulting in property damage and or injury.

Sequencer		LIST
# Sw	Names	
1 A	Door Cycle / Wheels	
2 Inh	Door Basic / Wheels	

You can program multiple functions to sequentially activate in response to an assigned switch. For example, an assigned Gear switch can open gear doors, lower the gear, then close the doors. In reverse, gear doors open, the gear retracts and the gear doors close.

You can assign each Sequencer function to a switch in most Function screens such as Flight Mode, Dual Rate, Mixing, Throttle Curve, Pitch Curve, etc.

You can assign several functions to a sequence to decrease the number of controls you need to touch during complex flight transitions—for example, applying your assigned dual rates and exponential when the landing gear deploys and the flight mode changes.

If you select an S-Number-A sequence (e.g. S2A), the sequence operates as a timed 5-position switch. An S-Number-B sequence operates as a timed 3-position switch. The 5 positions correspond to the sequencer values shown on the time delay graph in the second Sequencer screen. In a function screen, highlight each point (0–4) and select the switch position desired for a function to be active.

When S1B (or another sequence-number-B) is selected as a switch in a function, the sequence will operate as a timed 3-position switch. The 3 positions act as 'kick points' of the movement at fixed percentages (equal thirds) of the sequencer output. In a function screen, highlight each point (0–2) and select the switch position desired for a function to be active.

Sequencer		LIST
Switch: Switch A		Speed
Forward: 0 1		5.0
Reverse: 0 1		5.0
Name A: Door Cycle		<DOR
Name B: Wheels		<WHL
Chan A: Inh	Type A: Step	
Chan B: Inh	Type B: Step	NEXT

Sequencer Setup

- In the first Sequencer screen, select 1 of the 2 available sequences.
- In the second Sequencer screen, assign a switch to the sequence. We recommend using a 2-position switch.

Tip: If you need to use a 3-position switch, you must assign one direction to two adjacent switch positions—e.g., 0 and 1. Assign the opposite direction to the third switch position.
- Assign the timing for the Forward and Reverse directions as desired. There is no delay when you use the Nor option. You may also select a delay time between 0 and 30 seconds.
- Assign names for each sequencer function as desired.
- Select either **Step (S)** or **Proportional (P)** for the Sequencer output.

Step: The sequence only changes at kick points. Otherwise, there is a delay in the sequence until it reaches the next kick point.

Proportional: The sequence movement is proportional between kick points. The sequence maintains rate and direction until it reaches the next kick point.

- Adjust the Sequencer motion percentages in the third screen.

For example, you may move points 1, 2 and 3 closer to the beginning of the sequence so the motion occurs earlier. This results in a delay between point 3 and point 4 at the end of the sequence.

Testing the Sequence

The Sequencer function determines the response for channels included in the sequence.

Refer to the Monitor screen to see how respective channels interact in the Sequencer.

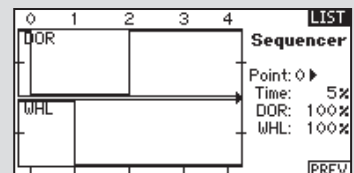

Range Test

The Range Test function reduces the power output. This allows for a range test to confirm the RF link is operating correctly. Perform a range check at the beginning of each flying session to confirm system operation.

To Access the Range Test screen:

1. With the transmitter on and the main or telemetry screen displayed, press the roller. The Function list displays.
2. Rotate the roller to highlight Range Test, then press the roller to access the Range Test function.
3. With the Range Test screen displayed, push and hold the trainer button. The screen displays Reduced Power. In this mode the RF output is reduced allowing for an operational range test of your system.
4. If you let go of the trainer button, the transmitter will go back to Full Power.

IMPORTANT: Telemetry alarms are disabled during the Range Test.

Range Testing the DX9

1. With the model restrained on the ground, stand 30 paces (approx. 90 feet/28 meters) away from the model.
2. Face the model with the transmitter in your normal flying position and place the transmitter into Range Test mode (see above). Then push the trainer button; the power output will be reduced.
3. Operate the controls. You should have total control of your model with the transmitter in Range Test mode.
4. If control issues occur, contact the appropriate Horizon Product Support office for assistance.
5. If performing a range test while a telemetry module is active, the display will show flight log data.

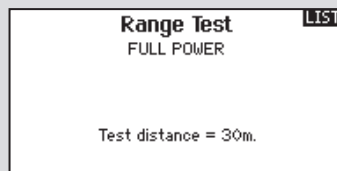

Timer

The DX9 Timer function allows you to program a countdown timer or stop watch (count up timer) to display on the main screen. An alarm sounds when the programmed time is reached. You can program the timer to start using the assigned switch position or automatically when throttle is raised above a programmed position. An internal timer that shows run time for a specific model displays on the Main Screen. A total system timer is also available.

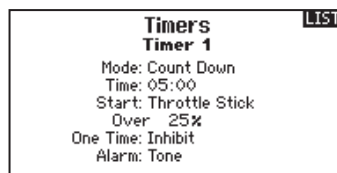

Telemetry

Telemetry is in both the system setup and the function list so you can access the telemetry functions from either list. You must power off the receiver and transmitter, then power them both on to reset the telemetry data. You can reset min/max values by pressing the CLEAR button.

NEVER change Telemetry settings when the aircraft is powered on. There is a brief interruption in RF output when exiting the Telemetry screen, and may cause a "Hold" condition.

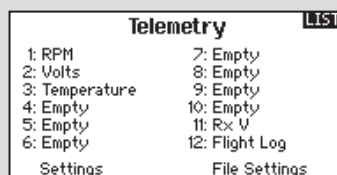

System Sounds

Scrolling to System Sounds and pressing the scroll wheel turns sounds on (Active) or off (Inhibit).

Volume Control

Volume control is adjusted from the Main Screen.

To change the volume:

1. Press the BACK button.
2. Turn the scroll wheel left or right to adjust the volume level.
3. Press the scroll wheel to save the selection.



Custom Voice Setup

Use the custom voice setup function to set up custom voice alerts or messages. For example, with the custom voice setup function you can be alerted to a switch change report or a sequence of alerts using the Stepping Events option. To add a new custom voice alert or command, enter the Custom Voice Setup function and select Add New Sound Event with the roller. Select either Switch Change Report or Stepping Events.

Switch Change Report

Use this feature to have telemetry read in a certain switch position, current switch position, or a variety of other alerts such as “Landing Flaps” or “Mix On”. Begin by selecting the switch you wish to use for the spoken alert, then select the desired setting next to each switch position.

Stepping Events

Stepping Events can be used to provide voice alerts when a switch is moved stepping through a list of events. Begin by selecting the switch desired to trigger each step through the list (when the switch is triggered as selected, the system will move to the next item on the list going through the list of user-defined selections one by one.) Auto-Cycle can be selected to Inhibit or Active. If inhibited, the system will go through the list 1 time only, if the switch is triggered again when at the final item in the list, it will not begin at the top of the list. If Active, the system will restart at the beginning of the list after the last item on the list with the next switch trigger. Steps is used to select the number of items on the list for the system to call. This can be set from 0 to 16. So there can be up to 16 items called to the pilot triggered by the switch selected. Next select the alert to be spoken for each stepped event on the list as desired. A variety of alerts can be chosen from the list including telemetry alerts and a variety of flight conditions and commands.

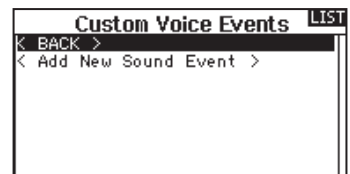
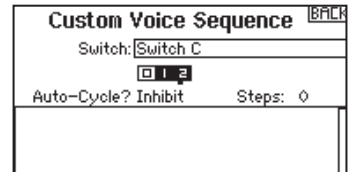

System Setup

Press here to enter the System List from the Function list without turning the transmitter off. A Caution screen will appear that warns that RF will be disabled (the transmitter will no longer transmit). Press YES if you are sure and want to access the System List. If you are not sure, press NO to exit to the main screen and continue operation.

If you do not press YES or NO, the system will exit to the main screen and continue operation within approximately 10 seconds.

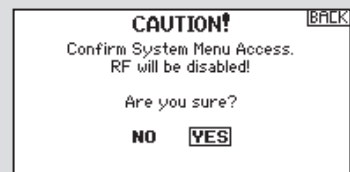

WARNING: Do not press YES unless the model is turned off or the model is secured.

Monitor

The Monitor screen displays the servo positions for each channel graphically and numerically. This is useful to verify programming functions, trim settings, mix directions, etc. The numeric value is directly relative to the travel adjust and mix values (e.g., 100% travel adjust equals 100% value in the Monitor).

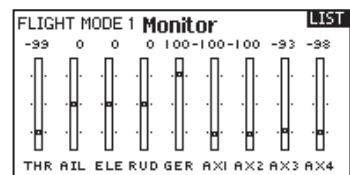

ACRO (AIRPLANE)



Acro Model Type

NOTICE: Refer to your airplane manual for recommended control throws.

CAUTION: Always do a Control Test of your model with the transmitter after programming to make sure your model responds as desired.

Aircraft Type

Use the Aircraft Type Screen to select wing and tail types to match your airplane model. Diagrams and setup names show on the transmitter screen to show the available setups.

Refer to spektrumrc.com for more information about new DX9 AirWare software updates to support these options.

Select wing and tail types before doing any other programming.

Wing

- Normal
- Flaperon*
- Dual Aileron*
- Flaperon*
- 1 Aileron 1 Flap*
- 1 Aileron 2 Flaps*
- 2 Ailerons 1 Flap*
- 2 Ailerons 2 Flaps*
- Elevon A*
- Elevon B*
- 4 Aileron*

Tail

- Normal
- V-Tail A**
- V-Tail B**
- Dual Elevator
- Dual Rudder
- Dual Rudder/Elevator

NEXT screen

- Gyro 1#
- Gyro 2#
- Gyro 3#
- Pitch Curve†

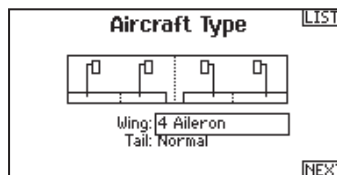

* Selection of multiple ailerons activates the Differential menu option.

** "V-Tail A" and "V-Tail B" function as internal servo reversing. If V-Tail A does not work correctly with your aircraft, try V-Tail B.

Activates the Gyro menu option in the Function List.

† Activates Pitch in the Function List. If Pitch Curve is active, only one gyro will be available.

Recommended Servo Connections

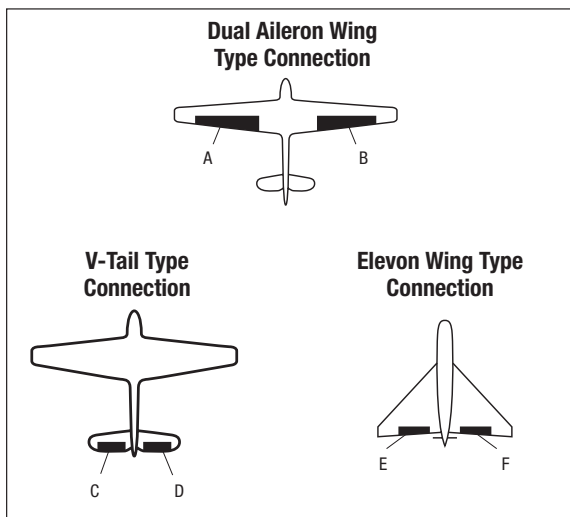

- A** AUX1 servo port (left aileron)
- B** AILE servo port (right aileron)
- C** ELEV servo port (left V-tail)
- D** RUDD servo port (right V-tail)
- E** AILE servo port (left aileron)
- F** ELEV servo port (right aileron)

Elevon Servo Control

The possible servo reversing options for a delta wing model are:

Aileron	Elevator
Normal	Reverse
Normal	Normal
Reverse	Reverse
Reverse	Normal

Tip: If you test all servo reversing options and the control surfaces do not move in the correct direction, change the Elevon wing type in the System Setup list from Elevon-A to Elevon-B.

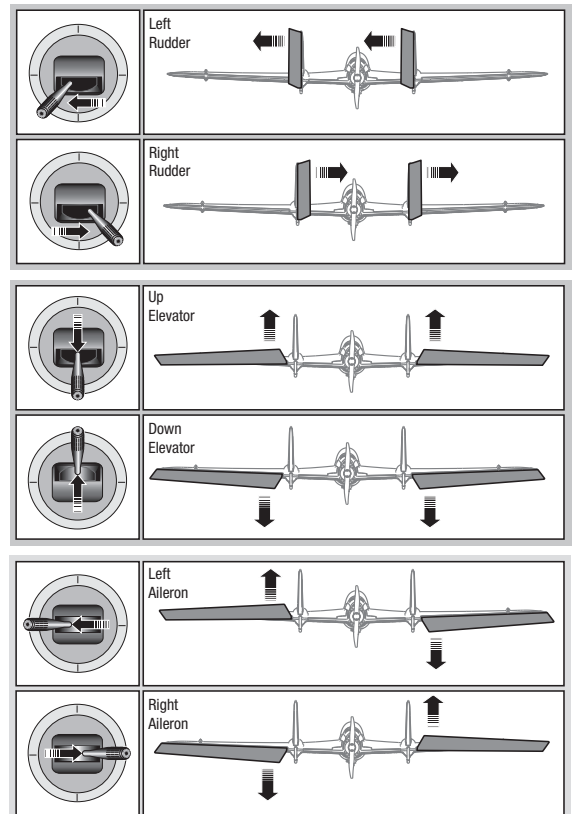

Flap System

The Flap System menu option enables flap programming as well as elevator mixing. You must select a flap-enabled wing type in Aircraft Type or the Flap System menu does not appear.

To activate the Flap System:

1. Access the System Setup list and select Aircraft Type.
2. Select a flap-enabled wing type and exit the System Setup list.
3. Access the Function List from the Main Screen and select Flap System.
4. Select Inhibit and scroll to the switch or lever you wish to use to control the flap channel.

5. Assign the Flap travel values and any desired Elevator mixing.
6. Select a Flap speed, if desired. Norm (default) does not have a delay. Flap speed options range from 0.1s to 30 seconds.

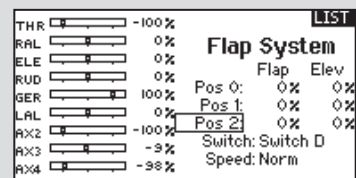

ACRO Mixing

Rudder to Aileron/Elevator

Rudder to Aileron/Elevator mixing corrects coupling in knife edge flight.

- Add Elevator mixing if the aircraft pitches toward the landing gear or canopy
- Add Aileron mixing if the aircraft rolls in knife edge flight

Aileron to Rudder

Use Aileron to Rudder mixing to overcome adverse yaw characteristics with certain types of aircraft (such as high-wing aircraft).

Elevator to Flap

Elevator to Flap mixing enables Flap movement when the Elevator stick moves. Use Elevator to Flap mixing to add the spoileron function to 3D aerobatic aircraft. This mix is available when a flap or dual aileron wing type is selected.



Acro Gyro Function

The Gyro menu option enables you to create up to 7 gyro gain points on a maximum of 4 curves. Gyro gain curves also provide flexibility in reducing gyro gain as the control stick moves farther away from the center.

To access the Gyro screen

1. In the System Setup List, highlight Aircraft Type.
2. In the Aircraft Type Screen, select **NEXT** at the bottom right of the screen. This will access the Aircraft Options screen. Activate the desired Gyro function(s). When the gyro function is active, the Gyro function appears in the Function List.

To program a Gyro curve:

1. Access the Gyro 1, Gyro 2 or Gyro 3 menu option from the Function list.
2. Assign either Aircraft or Heli to the Gyro Type.
3. Select a trim or a pot to use for a gyro gain trim if desired. Options available include: R. Knob, L Lever, R Lever, L TrimA, and R TrimA.
4. Scroll to Inh > Inh.
 - a. Select the first Inh and assign the input channel for the Gyro. For example, if the gyro is installed to assist on the ailerons, select Ail.
 - b. Select the second Inh and assign the output channel for the Gyro, for example, the Gear channel.
5. Select the Curve you wish to edit.
6. Add the desired gyro gain values to the points on the curve.
7. Assign the switch positions to activate the gyro curve. The curve is active when the box is solid.

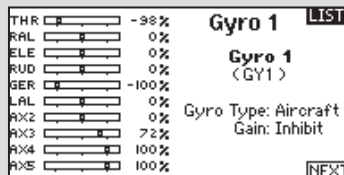
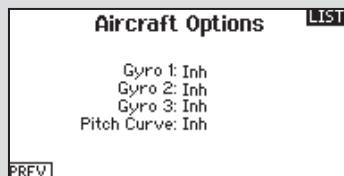

Pitch Curve Function

In Acro mode a Pitch Curve screen is available that allows a variable pitch propeller to be used. Up to 4 programmable curves are available that can be selected via a switch, knob or stick position. Up to 7 points can be programmed at the desired position on each curve. Note that the Pitch curve is driven by the throttle stick position.

To access the Pitch Curve screen:

1. In the System Setup List, highlight Aircraft Type.
2. In the Aircraft Type Screen, select **NEXT** at the bottom right of the screen. This will access the Aircraft Options screen. Activate the Pitch Curve function. When the Pitch Curve function is activated, the Pitch Curve function appears in the Function List.
3. Assign the pitch channel in the Channel Assignment function after activating the Pitch Curve Function.

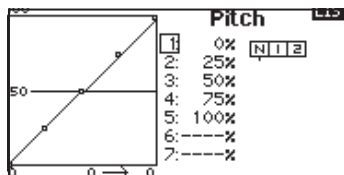

HELI (HELICOPTER)



Heli Model Type

NOTICE: Refer to your helicopter, gyro and governor manuals for programming recommendations.



CAUTION: Always do a Control Test of your model with the transmitter after programming changes to make sure your model responds as desired.

Swash Type

The Swash Type menu option assigns the swash type for your particular helicopter model.

Select the Swash Type before completing any programming in the Function List. The Swash Type will affect menu options in the Function List.

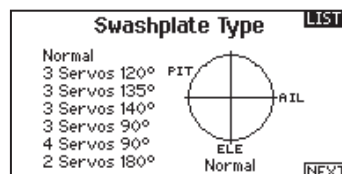

Collective Type

The collective type is used to turn on "Pull" collective for reversed collective. Available settings are Normal and Reverse. Press NEXT from the Swashplate Type screen to access the Collective Type screen. The Collective Type allows the throttle/pitch stick to operate in reverse and ensures trims, curves and all other functions that are to work in reverse function properly.

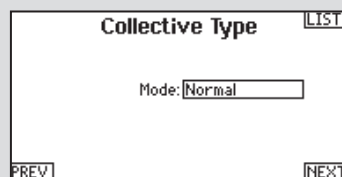

Pitch Curve

This function supports adjustment of collective pitch in 5 flight modes.

To adjust the Pitch Curve:

1. Select the Pitch Curve you wish to edit (N, 1 or 2).
2. Scroll right to select the points on the curve and edit the respective values.
3. Press the **BACK** button to save the Pitch Curves and return to the Function List.

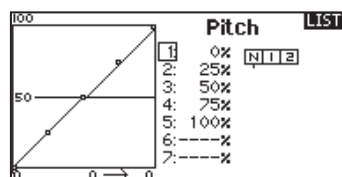

Swashplate

The Swashplate menu option enables you to adjust the following:

- Swashplate Mix
- Exponential
- E-Ring
- Elevator Compensation

Use positive or negative Swashplate mix values as needed for correct direction response of the helicopter.

Before making adjustments to the Swashplate mix, make sure the throttle/collective pitch input moves the entire swashplate up or down. If the servos are not moving in the same direction, reverse them as necessary in the Servo Setup menu option.

When the entire swashplate moves up or down:

1. Adjust the mix value for the Aileron and Elevator channels. If the servos do not move in the correct direction, change the direction of the mix—for example, a positive value instead of a negative value.
2. Adjust the mix value for the Pitch. If the swashplate does not move in the correct direction, change the direction of the value (negative instead of positive).

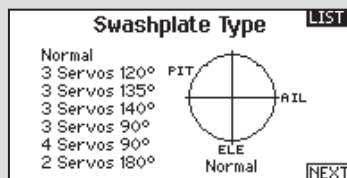

Always enable Expo when using a standard rotating-arm servo.

The Expo delivers linear movement of the swashplate from a standard rotary servo. When Expo is inhibited, the arm on a rotary servo moves on a curved path with decreased swashplate movement at the extremes of the servo arm travel.

NOTICE: Do not enable Expo when using a linear servo.

Electronic E-Ring

This feature prevents over driving servos by limiting servo travel if the sum of your cyclic and pitch inputs exceeds servo limits.

Gyro

The Gyro menu option enables you to assign a gyro gain value to an independent switch or a Flight Mode. Assign the receiver channel connected to the gyro, then assign the switch for gyro options. You can also assign values to available switch positions (from 1 to 5 rates are available, depending on the switch assigned). Make sure the gyro operates correctly and compensates in the correct direction.

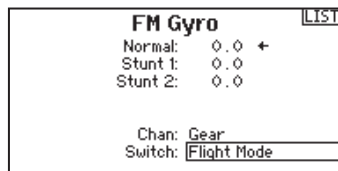

Governor

The governor function is used to set the rotor head speed when used with a governor installed in the helicopter. The governor onboard will control the engine RPM to maintain the head speed desired. You can program values for each switch position or flight mode. RPM values can be programmed in 0.5% steps.

To Program the Governor Function:

1. Access the Governor menu option.
2. Program the RPM values by rotating the scroll wheel to the desired value.
3. Press the scroll wheel and rotate it to the desired value. Press the scroll wheel again to save the value.

IMPORTANT: The value in the display is the corrected value. 0% is 1.5 ms or OFF for most governors. Repeat this for all governor settings.

4. Assign the output channel for the Governor. The Governor and the Gyro must be on different channels. We recommend using AUX2 for the Governor output channel.

5. Select a switch to control the Governor.

6. Press the **BACK** button to save the selections and return to the Function List.

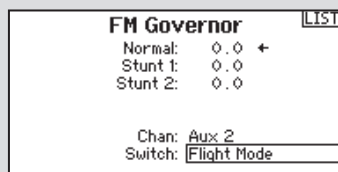

Tail Curve

The Tail Curve function mixes tail rotor input with the throttle/collective function to counter torque from the main rotor blades when using a non-heading hold (tail lock) gyro or when using rate mode on a gyro. See Pitch Curve for more information on programming curves.

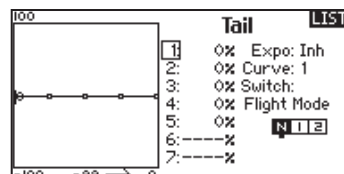

Mixing

Cyclic to Throttle

Cyclic-to-throttle mix prevents rpm loss when aileron, elevator or rudder inputs are given. This mix advances the throttle position with cyclic or rudder control to maintain rpm. At full throttle, Cyclic-to-Throttle mixing prevents the throttle from over driving the servo.

IMPORTANT: Do not use Cyclic to throttle mix when using a governor.

To verify that the Cyclic to Throttle mix is working properly and in the correct direction, move the flight mode switch to one of the active positions. Move the programmed cyclic or rudder channel, noting the throttle position. The throttle position should increase.

If the throttle decreases, then the opposite value (positive vs. negative) is needed.

Swashplate

The Swashplate Mix typically corrects swashplate timing issues by mixing Aileron to Elevator and Elevator to Aileron. When adjusted correctly, the Swashplate causes the helicopter to roll and pitch accurately with minimal interaction.



SAIL (SAILPLANE)



Sailplane Model Type

NOTICE: Refer to your sailplane manual for recommended control throws.

CAUTION: Always do a Control Test of your model with the transmitter after programming to make sure your model responds as desired.

Sailplane Type

Use the Sailplane Type Screen to select wing and tail types to match your sailplane model. Diagrams and setup names show on the transmitter screen to show the available setups.

Refer to spektrumrc.com for more information about new DX9 AirWare updates to support these options.

Wing

- 1 Servo
- 2 Aileron*
- 2 Aileron 1 Flap*
- 2 Aileron 2 Flap*
- 4 Aileron 2 Flap*

Tail

- Normal
- V-Tail A**
- V-Tail B**

Motor

- Inhibit
- Assign to a Switch (optional)

* Selection of multiple ailerons activates the Differential menu option.

** "V-Tail A" and "V-Tail B" function as internal servo reversing. If V-Tail A does not work correctly with your aircraft, try V-Tail B.

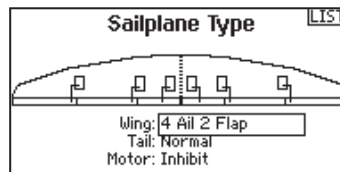

Camber Preset

Camber Preset is only available when 2 or 4 aileron wing type is selected in Sailplane Type. The Camber Preset function enables you to program the ailerons, flaps, wing tips and elevator for a specific position in each Flight Mode.

If flight modes are not active, only one preset position is available and it is always active.

The Camber Preset Speed enables the control surfaces to transition over a period of time, up to 30 seconds, when you change flight modes.

Move the flight mode switch to the desired position to change the Camber Preset values.

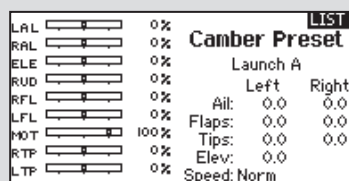

Camber System

Camber System is only available when 2 or 4 aileron wing type is selected in Sailplane Type. The Camber System allows in-flight camber adjustment and is also used as the braking system, often referred to as Crow or Butterfly. The Camber System enables you to assign the Camber System to a different switch in each flight mode.

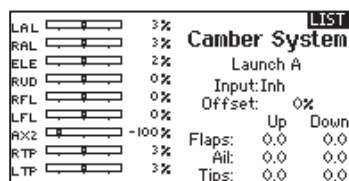

SAIL Mixing

For each of these mixes, you can program each flight mode with different mix values or at 0% if no mix is desired for that specific flight mode. Programming values include independent control of the direction and amount a slave surface moves in relationship to the master surface.

Aileron to Rudder

The Aileron to Rudder mix is commonly used for coordinated turns. When active, as aileron is applied the rudder moves in the same direction as the turn (right aileron input results in right rudder output). If you assign the flight mode to a switch, a Sub Switch option allows you to assign an additional switch to activate up to 3 Aileron to Rudder mixes for that flight mode.

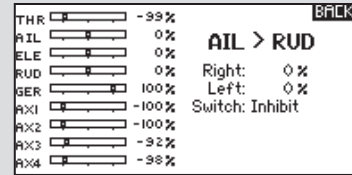

Aileron to Flap

The Aileron to Flap mix allows the entire trailing edge of the wing (aileron and flap) to operate as ailerons. When active, as aileron is applied the flaps also move. Always program the flaps to move in the same direction as the turn (so that right aileron is equivalent to flaps moving as right ailerons).

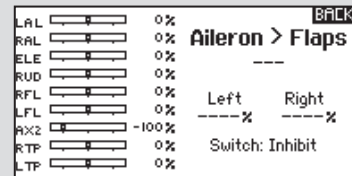

Elevator to Flap

Elevator to Flap mix creates additional lift, allowing a tighter turn. The entire trailing edge of the wing (aileron and flap) operates as flaps (camber increase) when you apply elevator. An offset is provided, which is typically used for Snap Flaps. With Snap Flap, no Elevator to Flap mix occurs until the offset value is reached. Typically, this offset is at 70% up elevator so that beyond 70% the down flap mix comes in, providing additional lift for more aggressive turning (for tight thermals or racing turns).

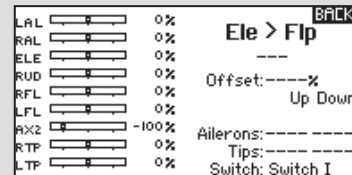

Flap to Elevator

Flap to Elevator mix prevents pitch up tendency that occurs when you apply Crow or Butterfly. This mix is typically used only with the Camber System. The Flap to Elevator mix operates as a curve so that the elevator moves down the most during the first 20% of flap deployment, decreases over the next 40%, then remains the same from 60 to 100% of flap travel.

For sailplanes with ailerons/tips/flaps, make sure an appropriate Sailplane Type is selected so that tips appear in the transmitter as RAIL and LAIL. Decrease or increase travel on the tip ailerons by creating an AIL > RAIL mix.

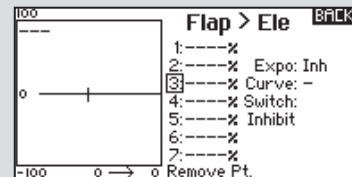

PHYSICAL TRANSMITTER ADJUSTMENTS

Transmitter Mode Conversion

You can change transmitter modes among Modes 1, 2, 3 and 4. This conversion requires both a programming and a mechanical change.

Programming Conversion:

1. Access the System Settings menu from the Setup List and select the desired Mode. If you are changing between Modes 2/4 or 1/3, you can STOP after Step 1.
2. Exit the System Settings menu to save the selection.
3. Power off the transmitter and remove the transmitter battery pack.

After you change the transmitter Mode in the Setup List, you will need to make mechanical changes to the transmitter gimbals.

Mechanical Conversion



CAUTION: Always power off the transmitter, disconnect and remove the battery before adjusting stick tension or friction straps. Not doing so could result in property damage or injury.

Mechanical conversion is required to change between Modes 1 and 2 or between Modes 3 and 4. The mechanical conversion consists of the following steps:

1. *Change the Throttle Ratchet*
2. *Adjust the Elevator Centering Screw*
3. *Move the Throttle Limit Wedges*

Changing the Throttle Ratchet

1. Remove the eight Phillips head screws including the two antenna cover screws that secure the rear transmitter case half.
2. Put the transmitter face down on a piece of foam or a towel and remove the lower back case. Carefully pull the antenna cover off the top of the transmitter and set the back case aside.



CAUTION: Use care to not pull or disconnect any of the wires attached to the back transmitter half.

3. Locate the silver throttle friction straps on both gimbals. One strap engages a serrated section on the gimbal for a ratcheted throttle, while the other strap engages the smooth section on the gimbal.
4. To change the throttle ratchet, loosen the throttle strap so it does not touch the throttle gimbal. Tighten the opposite throttle strap to engage the desired throttle ratchet.

If you only need to adjust the throttle friction, see the Adjust Throttle Friction Straps section.

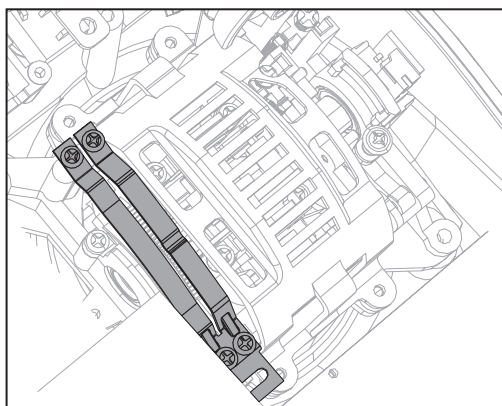
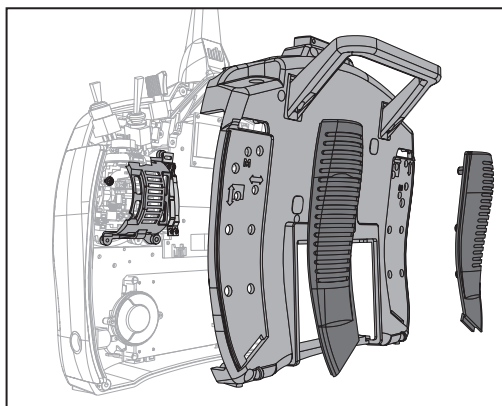

Adjusting the Elevator Centering Screw

When changing between Modes 1 and 2, or between Modes 3 and 4, you must adjust the elevator centering screw.

1. Hold the Elevator or Throttle stick in the full up or full down position when you are adjusting the elevator centering screw. Holding the gimbal stick reduces the load on the elevator centering mechanism and makes it easier to adjust the centering screw.
2. Locate the gimbal where the elevator centering spring is engaged. Use a Phillips screwdriver to tighten the elevator centering screw. Tightening the screw will disengage the centering spring.
3. Using a Phillips screwdriver, loosen the opposite elevator centering screw until the lever engages.

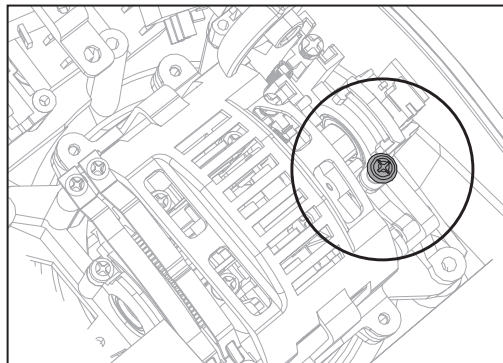

Moving the Throttle Limiting Wedges

Throttle limiting wedges are used to limit the maximum throttle travel. When changing between Modes 1 and 2, or between Modes 3 and 4, you must move the throttle limit wedges.

1. Remove four screws from two boards near the top of the front of the case. These screws are different sizes for electrical safety purposes; you must return them to the same places you remove them from.
2. Carefully move the boards a small amount to get to the screws holding the gimbal cages on the gimbals.
3. Use a Phillips screwdriver to remove eight screws and two gimbal cages from the gimbals. Make sure no wire connectors are disconnected when moving the gimbal cages.
4. Move the gimbals a small amount to remove a screw and wedge from the top and bottom of the throttle gimbal.
5. Install the wedges on the other gimbal using two screws.
6. Install the boards using the four screws.
7. Install the cages on the gimbals using the eight screws.

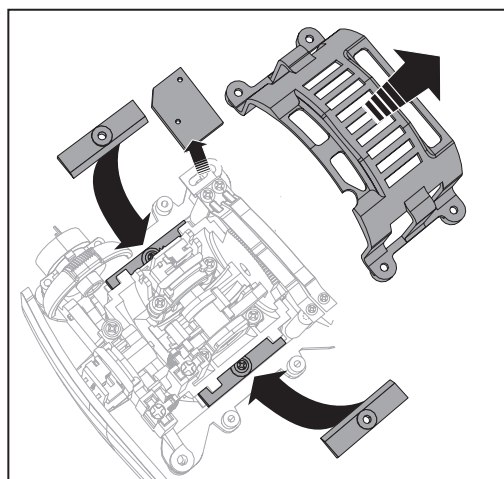

Re-assembling the Transmitter

1. Put the back of the transmitter case on the main case, taking care to not pinch any wires. Also install the top antenna cover.
2. Install and tighten the eight Phillips screws including the 2 antenna cover screws.
3. Install the rubber grips on the transmitter.
4. Power on the transmitter. When a calibration screen shows, move the control sticks to extremes and to centers as directed to correctly calibrate controls.

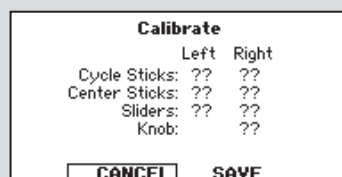

Adjust Stick Tension

Adjust stick tension using the screws on the stick gimbals through holes in the back of the transmitter.

1. Pull up the top of the rear grip on the back of the transmitter to adjust the stick gimbal tension. Only the top of the grip must be pulled up to access the adjustment screw. The entire grip does not need to be removed.
2. Turn the screws in these holes marked with a vertical or horizontal arrow a small amount using a small Phillips screwdriver.

NOTICE: Always do a test of stick tension while turning these screws to ensure stick tension is not too loose or too tight. Tightening a screw too much can damage a spring. Loosening a screw too much can let a spring fall off and cause short-circuit in the transmitter.

CAUTION: Always power off the transmitter, disconnect and remove the battery before adjusting stick tension or friction straps. Not doing so could result in property damage or injury.

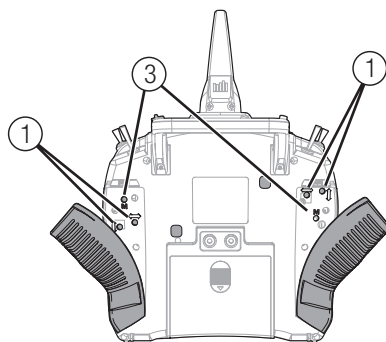

Function	
①	Gimbal spring access
②	Throttle friction strip tension cover
③	Mode change access

Adjust Throttle Friction Straps

To adjust Throttle Friction:

1. Remove rubber plugs from holes on the back of the transmitter.
2. Use a small Phillips screwdriver to tighten or loosen the screw for the friction strip.
3. Reinstall the plug after completing the adjustment as desired.

CAUTION: Always power off the transmitter, disconnect and remove the battery before adjusting stick tension or friction straps. Not doing so could result in property damage or injury.

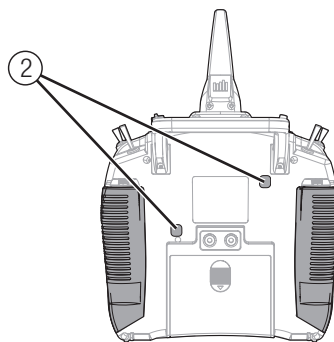

Adjusting the Throttle Ratchet Strap

The user can loosen the friction strap screw and tighten the ratchet screw if desired by pulling the top of the grip through the throttle adjustment opening.

No installation required, no need to remove the case back.

You can adjust the Throttle Ratchet Strap to use either a smooth throttle or ratchet throttle.

To adjust the Throttle Ratchet Strap:

1. Remove rubber plugs from holes on the back of the transmitter.
2. Using a #0 Phillips screwdriver, loosen or tighten the Throttle Ratchet Strap screw to adjust the ratchet to your liking.
3. Re-install the plug.

Control Stick Length Adjustment

To adjust the Control Stick Length:

1. Using a 2mm Allen wrench, turn the setscrew in the stick counterclockwise to loosen it.
2. Make the stick shorter by turning it clockwise or longer by turning it counterclockwise.
3. After adjustment of stick length, tighten the setscrew.

TROUBLESHOOTING GUIDE

Problem	Possible Cause	Solution
Aircraft will not Bind (during binding) to transmitter	Transmitter too near aircraft during binding process	Move powered transmitter a few feet from aircraft, disconnect and reconnect flight battery to aircraft
	Aircraft or transmitter is too close to large metal object	Move the aircraft or transmitter away from the large metal object
	The bind plug is not installed correctly in the bind port	Install bind plug in bind port and bind the aircraft to the transmitter
	Flight battery/Transmitter battery charge is too low	Replace/recharge batteries
Aircraft will not link (after binding) to transmitter	Transmitter too near aircraft during linking process	Move powered transmitter a few feet from aircraft, disconnect and reconnect flight battery to aircraft
	Aircraft or transmitter is too close to large metal object	Move the aircraft or transmitter away from the large metal object
	Bind plug left installed in bind port	Rebind transmitter to the aircraft and remove the bind plug before cycling power
	Aircraft bound to different model memory (ModelMatch™ radios only)	Select correct model memory on transmitter
	Flight battery/Transmitter battery charge is too low	Replace/recharge batteries
	Transmitter may have been bound using different DSM protocol	Bind aircraft to transmitter
	Damaged remote receiver or receiver extension.	Required remote receiver is not connected.
The receiver goes into failsafe mode a short distance away from the transmitter	Check the receiver antenna to be sure it is not cut or damaged	Replace or contact Horizon Product Support
	Main and remote receivers too near each other	Install main and remote receivers at least 2 inches (51mm) apart
Receiver quits responding during operation	Low battery voltage	Completely recharge flight battery
	Loose or damaged wires or connectors between battery and receiver	Do a check of the wires and connection between battery and receiver. Repair or replace wires and/or connectors
Receiver loses its bind	Bind button pressed before transmitter powered on	Rebind by performing binding instructions
Receiver slowly blinking at landing (DSM2 Only)	Loss of power to the receiver during flight	Check battery voltage
	System powered on and connected, then receiver powered off without powering off transmitter	Power off transmitter when receiver is powered off
Flight log registers undesirable number of fades, losses or holds or aircraft responds irregularly to controls	Poor signal reception	Reposition remote receivers for improved RF signal path diversity
	Electronic feedback	Check for and stop feedback from servos or motor systems to the ESC or receiver
	Low power	Check aircraft power draw and increase battery power or decrease power demand by installed systems. Ensure all aircraft batteries are fully charged. Ensure the installed BEC for an electric aircraft is adequate for the power demand

1-YEAR LIMITED WARRANTY

What this Warranty Covers

Horizon Hobby, Inc., (Horizon) warrants to the original purchaser that the product purchased (the "Product") will be free from defects in materials and workmanship for a period of 1 years from the date of purchase.

What is Not Covered

This warranty is not transferable and does not cover (i) cosmetic damage, (ii) damage due to acts of God, accident, misuse, abuse, negligence, commercial use, or due to improper use, installation, operation or maintenance, (iii) modification of or to any part of the Product, (iv) attempted service by anyone other than a Horizon Hobby authorized service center, (v) Product not purchased from an authorized Horizon dealer, or (vi) Product not compliant with applicable technical regulations.

OTHER THAN THE EXPRESS WARRANTY ABOVE, HORIZON MAKES NO OTHER WARRANTY OR REPRESENTATION, AND HEREBY DISCLAIMS ANY AND ALL IMPLIED WARRANTIES, INCLUDING, WITHOUT LIMITATION, THE IMPLIED WARRANTIES OF NON-INFRINGEMENT, MERCHANTABILITY AND FITNESS FOR A PARTICULAR PURPOSE. THE PURCHASER ACKNOWLEDGES THAT THEY ALONE HAVE DETERMINED THAT THE PRODUCT WILL SUITABLY MEET THE REQUIREMENTS OF THE PURCHASER'S INTENDED USE.

Purchaser's Remedy

Horizon's sole obligation and purchaser's sole and exclusive remedy shall be that Horizon will, at its option, either (i) service, or (ii) replace, any Product determined by Horizon to be defective. Horizon reserves the right to inspect any and all Product(s) involved in a warranty claim. Service or replacement decisions are at the sole discretion of Horizon. Proof of purchase is required for all warranty claims. SERVICE OR REPLACEMENT AS PROVIDED UNDER THIS WARRANTY IS THE PURCHASER'S SOLE AND EXCLUSIVE REMEDY.

Limitation of Liability

HORIZON SHALL NOT BE LIABLE FOR SPECIAL, INDIRECT, INCIDENTAL OR CONSEQUENTIAL DAMAGES, LOSS OF PROFITS OR PRODUCTION OR COMMERCIAL LOSS IN ANY WAY, REGARDLESS OF WHETHER SUCH CLAIM IS BASED IN CONTRACT, WARRANTY, TORT, NEGLIGENCE, STRICT LIABILITY OR ANY OTHER THEORY OF LIABILITY, EVEN IF HORIZON HAS BEEN ADVISED OF THE POSSIBILITY OF SUCH DAMAGES. Further, in no event shall the liability of Horizon exceed the individual price of the Product on which liability is asserted. As Horizon has no control over use, setup, final assembly, modification or misuse, no liability shall be assumed nor accepted for any resulting damage or injury. By the act of use, setup or assembly, the user accepts all resulting liability. If you as the purchaser or user are not prepared to accept the liability associated with the use of the Product, purchaser is advised to return the Product immediately in new and unused condition to the place of purchase.

Law

These terms are governed by Illinois law (without regard to conflict of law principals). This warranty gives you specific legal rights, and you may also have other rights which vary from state to state. Horizon reserves the right to change or modify this warranty at any time without notice.

WARRANTY SERVICES

Questions, Assistance, and Services

Your local hobby store and/or place of purchase cannot provide warranty support or service. Once assembly, setup or use of the Product has been started, you must contact your local distributor or Horizon directly. This will enable Horizon to better answer your

questions and service you in the event that you may need any assistance. For questions or assistance, please visit our website at www.horizonhobby.com, submit a Product Support Inquiry, or call the toll free telephone number referenced in the Warranty and Service Contact Information section to speak with a Product Support representative.

Inspection or Services

If this Product needs to be inspected or serviced and is compliant in the country you live and use the Product in, please use the Horizon Online Service Request submission process found on our website or call Horizon to obtain a Return Merchandise Authorization (RMA) number. Pack the Product securely using a shipping carton. Please note that original boxes may be included, but are not designed to withstand the rigors of shipping without additional protection. Ship via a carrier that provides tracking and insurance for lost or damaged parcels, as Horizon is not responsible for merchandise until it arrives and is accepted at our facility. An Online Service Request is available at http://www.horizonhobby.com/content/_service-center_render-service-center. If you do not have internet access, please contact Horizon Product Support to obtain a RMA number along with instructions for submitting your product for service. When calling Horizon, you will be asked to provide your complete name, street address, email address and phone number where you can be reached during business hours. When sending product into Horizon, please include your RMA number, a list of the included items, and a brief summary of the problem. A copy of your original sales receipt must be included for warranty consideration. Be sure your name, address, and RMA number are clearly written on the outside of the shipping carton.

NOTICE: Do not ship LiPo batteries to Horizon. If you have any issue with a LiPo battery, please contact the appropriate Horizon Product Support office.

Warranty Requirements

For Warranty consideration, you must include your original sales receipt verifying the proof-of-purchase date. Provided warranty conditions have been met, your Product will be serviced or replaced free of charge. Service or replacement decisions are at the sole discretion of Horizon.

Non-Warranty Service

Should your service not be covered by warranty, service will be completed and payment will be required without notification or estimate of the expense unless the expense exceeds 50% of the retail purchase cost. By submitting the item for service you are agreeing to payment of the service without notification. Service estimates are available upon request. You must include this request with your item submitted for service. Non-warranty service estimates will be billed a minimum of ½ hour of labor. In addition you will be billed for return freight. Horizon accepts money orders and cashier's checks, as well as Visa, MasterCard, American Express, and Discover cards. By submitting any item to Horizon for service, you are agreeing to Horizon's Terms and Conditions found on our website http://www.horizonhobby.com/content/_service-center_render-service-center.

ATTENTION: Horizon service is limited to Product compliant in the country of use and ownership. If received, a non-compliant Product will not be serviced. Further, the sender will be responsible for arranging return shipment of the un-serviced Product, through a carrier of the sender's choice and at the sender's expense. Horizon will hold non-compliant Product for a period of 60 days from notification, after which it will be discarded.

WARRANTY AND SERVICE CONTACT INFORMATION

Country of Purchase	Horizon Hobby	Contact Information	Address
United States of America	Horizon Service Center (Repairs and Repair Requests)	servicecenter.horizonhobby.com/ RequestForm/	4105 Fieldstone Rd Champaign, Illinois, 61822 USA
	Horizon Product Support (Product Technical Assistance)	www.quickbase.com/db/ bghj7ey8c?a=GenNewRecord Heli 888-959-2304 Air 888-959-2305	
	Sales	sales@horizonhobby.com Heli 888-959-2304 Air 888-959-2305	
United Kingdom	Service/Parts/Sales: Horizon Hobby Limited	sales@horizonhobby.co.uk +44 (0) 1279 641 097	Units 1–4 , Ployters Rd, Staple Tye Harlow, Essex, CM18 7NS, United Kingdom
Germany	Horizon Technischer Service	service@horizonhobby.de	Christian-Junge-Straße 1 25337 Elmshorn, Germany
	Sales: Horizon Hobby GmbH	+49 (0) 4121 2655 100	
France	Service/Parts/Sales: Horizon Hobby SAS	infofrance@horizonhobby.com +33 (0) 1 60 18 34 90	11 Rue Georges Charpak 77127 Lieusaint, France
China	Service/Parts/Sales: Horizon Hobby – China	info@horizonhobby.com.cn +86 (021) 5180 9868	Room 506, No. 97 Changshou Rd. Shanghai, China 200060

FCC INFORMATION

This device complies with part 15 of the FCC rules. Operation is subject to the following two conditions:

1. This device may not cause harmful interference.
2. This device must accept any interference received, including interference that may cause undesired operation.

CAUTION: Changes or modifications not expressly approved by the party responsible for compliance could void the user's authority to operate the equipment.

This product contains a radio transmitter with wireless technology which has been tested and found to be compliant with the applicable regulations governing a radio transmitter in the 2.400GHz to 2.4835GHz frequency range.

IC Information

This device complies with Industry Canada licence-exempt RSS standard(s). Operation is subject to the following two conditions: (1) this device may not cause interference, and (2) this device must accept any interference, including interference that may cause undesired operation of the device.

FAA INFORMATION

Prior to flying, contact your local or regional modeling organizations for guidance and familiarize yourself with the current local rules and FAA regulations governing model aviation in your location.

AMA National Model Aircraft Safety Code

<http://www.modelaircraft.org/files/105.PDF>

Antenna Separation Distance

When operating your Spektrum transmitter, please be sure to maintain a separation distance of at least 5 cm between your body (excluding fingers, hands, wrists, ankles and feet) and the antenna to meet RF exposure safety requirements as determined by FCC regulations.

The following illustrations show the approximate 5 cm RF exposure area and typical hand placement when operating your Spektrum transmitter.

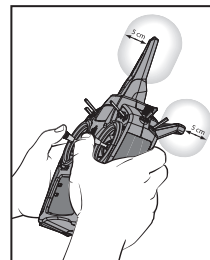

COMPLIANCE INFORMATION FOR THE EUROPEAN UNION

AT	BE	BG	CZ	CY	DE	DK
EE	ES	FI	FR	GR	HR	HU
IE	IT	LT	LU	LV	MT	NL
PL	PT	RO	SE	SI	SK	UK
IS	LI	NO	CH			

Declaration of Conformity

(in accordance with ISO/IEC 17050-1)

No. HH2013090201

Product(s): SPM DX9 Transmitter Only MD2

Item Number(s): SPMR9900EU

Equipment class: 2

The object of declaration described above is in conformity with the requirements of the specifications listed below, following the provisions of the European R&TTE directive 1999/5/EC, EMC Directive 2004/108/EC and LVD Directive 2006/95/EC:

EN 300-328 V1.7.1: 2006

EN 301 489-1 V1.9.2: 2012

EN301 489-17 V2.1.1: 2009

EN60950-1:2006+A11:2009+A1:2010+A12: 2011

EN55022:2010 + AC:2011

EN55024:2010

EN61000-3-2:2006+A1:2009+A2:2009

EN61000-3-3:2008



Signed for and on behalf of:
Horizon Hobby, Inc.
Champaign, IL USA
Sep 2, 2013

Robert Peak
Chief Financial Officer
Horizon Hobby, Inc.



Instructions for disposal of WEEE by users in the European Union

This product must not be disposed of with other waste. Instead, it is the user's responsibility to dispose of their waste equipment by handing it over to a designated collections point for the recycling of waste electrical and electronic equipment. The separate collection and recycling of your waste equipment at the time of disposal will help to conserve natural resources and ensure that it is recycled in a manner that protects human health and the environment. For more information about where you can drop off your waste equipment for recycling, please contact your local city office, your household waste disposal service or where you purchased the product.

REPLACEMENT PARTS • ERSATZTEILE • PIÈCES DE RECHANGE • PEZZI DI RICAMBIO • PIEZAS DE RECAMBIO

Part # Nummer Número Codice	Description	Beschreibung	Description	Descrizione	Descripción
SPMA9592	Back Grips (Left/Right): DX9	Spektrum DX9 : hintere Griffe (links/ rechts)	DX9 - Grips en caoutchouc arrière (gauche/droit)	Impugnatura poste- riori (destra/sinistra)	Empuñaduras traseras (Izquierda/Derecha): DX9
SPMA9593	Side Grips (Left/Right): DX9	Spektrum DX9: seitliche Griffe (links/ rechts)	DX9 - Grips en caoutchouc latéraux (gauche/droit)	Impugnatura laterali (destra/sinistra)	Empuñaduras laterales (Izquierda/ Derecha): DX9
SPMA9594	Battery Door: DX9	Spektrum DX9 : Akkuklappe	DX9 - Couvercle de compartiment à batterie	Coperchio batteria	Tapa de batería: DX9
SPMA9595	Foam Battery Spacers: DX9	Spektrum DX9: Schaumeinsätze Akkufach	DX9 - Butées de batterie en mousse	Distanziali batteria	Espaciadores de foam para batería: DX9
SPMA4004	Stick Ends: DX9	Spektrum DX9: Steuerknüppelend- stück	DX9 - Embouts de manches	Terminali stick	Extremos de los sticks: DX9
SPMB2000LITX	2000 mAh TX Battery: DX9	Spektrum DX9: 2000mAh Sender- akku	DX9 - Batterie TX 2000mA	Batteria TX 2000mAh	Batería 2000 mAh Tx: DX9
SPM9551	International 12V Trans- mitter AC Adapter	Spektrum Netzteil: DX9	Adaptateur secteur international	Alimentatore inter- nazionale AC per 12V su trasmettitore	Adaptador internacio- nal AC de 12V
SPM6708	Spektrum Single Stand Up Transmitter Case	Spektrum Einzelsender Koffer	Valise pour émetteur Spektrum	Valigia trasmettitore Spektrum a supporto singolo	Maletín individual Spektrum
SPM6709	Spektrum Single Stand Up Transmitter Case Foam	Spektrum Schaumeinlage Einzelsenderkoffer	Mousse pour émetteur Spektrum	Spugna per valigia trasmettitore Spe- ktrum a supporto singolo	Foam interior de maletín individual Spektrum
SPM6712	Spektrum Dual Stand Up Transmitter Case Foam	Spektrum Schau- meinlage Dop- pelsenderkoffer	Mousse Valise pour 2 émetteurs Spektrum	Spugna per valigia trasmettitore Spe- ktrum a supporto doppio	Foam intero de maletín doble de Spektrum
SPM6803	Male/Female Universal Bind Plug	Spektrum Stecker/ Buchse Binde Stecker	Prise d'affectation Mâle/femelle	Bind plug universale maschio/femmina	Conector de asig- nación macho/hembra
SPM9540	Spektrum Flight Log	Spektrum Flugsch- reiber	Flight Log Spektrum	Registratore di volo Spektrum	Fligh Log de Spektrum
HAN172	Digital Servo and Receiver Current Meter: Hangar 9	Hangar 9 Digital Servo & RX Strom- meßgerät	Multimètre Hangar 9	Misuratore digitale di corrente per servi e ricevitore	Medidor de corriente de servos y receptor: Hangar 9
SPM6805	Trainer Cord	Spektrum Trainerkabel	Cordon écolage	Cavo trainer	Cable de entrenador

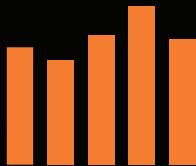

SPEKTRUM®

© 2013 Horizon Hobby, Inc.

The Spektrum trademark is used with permission of Bachmann Industries, Inc. DSM2, DSMX, AirWare, SimpleScroll, ModelMatch, JR, Vibe and Bind-N-Fly are trademarks or registered trademarks of Horizon Hobby, Inc.

The SD Logo is a trademark of SD-3C, LLC
US 7,391,320. Other patents pending.

www.spektrumrc.com

Created 8/13 39673 SPMR9900